

BAHCO®

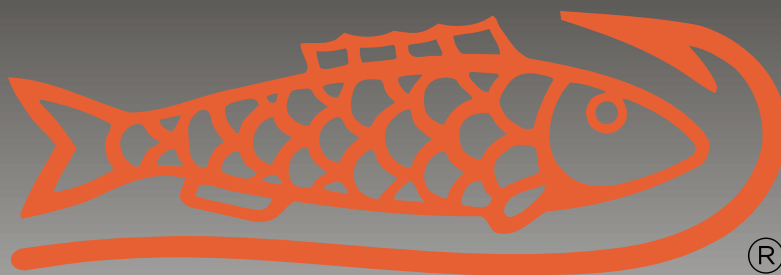

PRŮMYSL

Profesionálům dáváme to, co potřebují



BAHCO

SNA Europe, dceřiná společnost společnosti Snap-on Inc., je předním výrobcem ručního nářadí a nářadí na zpracování kovů. Výrobky se prodávají na celém světě prostřednictvím obchodních partnerů pod značkami Bahco, Lindström a Irimo.

Od výroby prvního ručního nářadí ve Švédsku v roce 1850 jsme vyvíjeli a vyráběli nářadí pro profesionály v našich vlastních evropských výrobních závodech. Naše nářadí se vyznačuje vysokou kvalitou a ergonomickým designem, což zvyšuje produktivitu, pohodlí a bezpečnost na pracovišti.

Dnes nabízíme více než 15 000 výrobků, široký sortiment pro uživatele v oblastech průmyslu, letectví, automobilů, řemesel, zahradnictví a terénních úprav, jakož i pěstování ovoce a vína.

PROFESIONÁLŮM DÁVÁME TO, CO POTŘEBUJÍ

V nejnovějším vydání kampaně pro průmysl, představuje společnost Bahco, výběr své komplexní produktové řady bezpečného, vysoce kvalitního a ergonomického nářadí. Obsahuje novinky, nejprodávanější nářadí, dílenské vozíky a jiné. Profesionální řešení výběru nářadí pro průmysl.

Obsah	Strana	Obsah	Strana
Fit & Go Moduly nářadí	4–7	Klíče	52–57
Dílenské vozíky	8–15	Kleště	58–61
Nářadí z nerezové oceli	16–19	Pneumatické nářadí	62–63
Nářadí pro práci vo výšce	20–23	Pilové pásy	64
Nejiskřivé nářadí	24–25	Pilníky a rašple	65
Izolované nářadí	26–29	Děrovací pily	66
Momentové nářadí	30–33	Pilky na kov	67
Akumulátorové nářadí	34–37	Kufry na nářadí	68–69
Šroubováky a bity	38–43	Brašny na nářadí	70–71
Ráčny a nástrčné klíče	44–45	Automotive	72
Sady nástrčných klíčů	46–51	Inspekční nářadí, svítilny	73

Všechny údaje zobrazené v tomto materiálu jsou orientační a nezávazné. Změny jsou vyhrazeny. Všechny uvedené ceny jsou bez DPH, platné do 31.12.2020 nebo do vyprodání zásob.

1/3 MODULY FIT&GO

FF1E1002

Šroubováky ERGO™ pro šrouby s drážkou Phillips

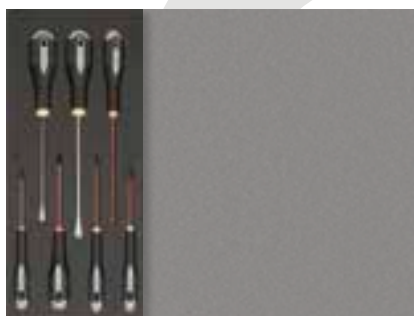

	1/3	2/3	3/3
BE-8030	●	○ 0.6x3.5x75	
BE-8040	●	○ 0.8x4.0x100	
BE-8242	●	○ 1.0x5.5x150	
BE-8255	●	○ 1.2x6.5x150	
BE-8257	●	○ 1.6x8.0x175	
BE-8611	●	● PH1 x75	
BE-8621	●	● PH2 x100	

FF1E1009

Šroubováky ERGO™ pro šrouby s drážkou TORX®

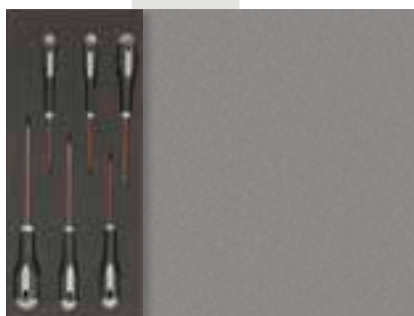

	1/3	2/3	3/3
BE-8908	●	● T8 x75	
BE-8910	●	● T10 x75	
BE-8915	●	● T15 x100	
BE-8920	●	● T20 x100	
BE-8925	●	● T25 x125	
BE-8930	●	● T30 x150	

FF1E1010

Izolované šroubováky ERGO™ pro šrouby s rovnou drážkou a drážkou Phillips

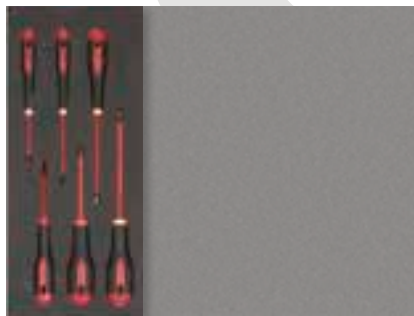

	1/3	2/3	3/3
BE-8010S	1,000 V	●	○ 0.4x2.5x75
BE-8230S	1,000 V	●	○ 0.6x3.5x100
BE-8050S	1,000 V	●	○ 1.0x5.5x125
BE-8255S	1,000 V	●	○ 1.2x6.5x150
BE-8610S	1,000 V	●	● PH1 x75
BE-8620S	1,000 V	●	● PH2 x100

FF1E2001

Sada nástrčných klíčů 1/4"

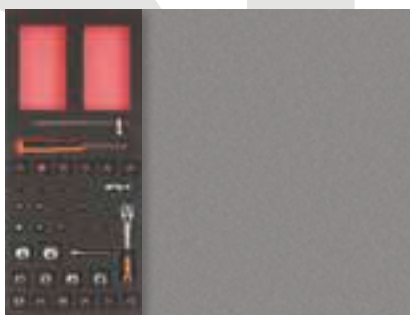

	1/3	2/3	3/3
6700SM	○	○ 1/4"	○ 4-5-5.5-6-7-8-9-10-11-12-13-14 mm
6700TORX-E	○	○ 1/4"	E4-E5-E6-E7-E8-E10
6709M	●	● 1/4"	3-4-5-6-8 mm
6709TORX	●	● 1/4"	T8-T9-T10-T15-T20-T25-T27-T30-T40
6950SL	○	○ 1/4"	○ 1/4" - 120 mm
6954	○	○ 1/4"	○ 1/4" - 115 mm
6956	○	○ 1/4"	○ 1/4" - 150 mm
6960	○	○ 1/4"	○ 1/4" - 50 mm
6966	○	○ 1/4"	○ 1/4" - 35 mm

FF1E2201

Sada nástrčných klíčů 1/2"

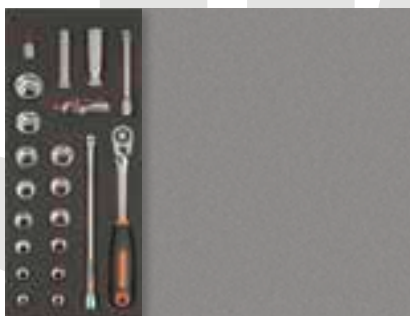

	1/3	2/3	3/3
7800SM	○	○ 1/2"	○ 10-11-12-13-14-15-17-18-19-20-21-22-24-27 mm
7805SM	○	○ 1/2"	○ 16-21 mm
8150SL	○	○ 1/2"	○ 1/2" - 265 mm
8160-1/2	○	○ 1/2"	○ 1/2" - 125 mm
8162-1/2	○	○ 1/2"	○ 1/2" - 250 mm
8166-1/2	○	○ 1/2"	○ 1/2" - 72 mm
8165-1/2	○	○ 1/2"	○ 3/8" - 37 mm

FF1E2204

Sada nástrčných klíčů 1/2"

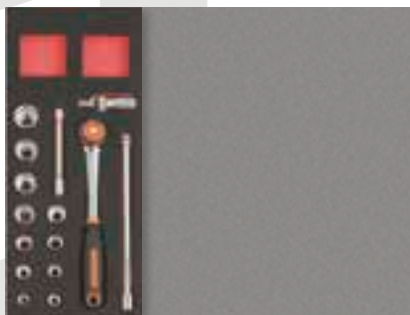

	1/3	2/3	3/3

7800DZ	○	○ 1/2"	○ 3/8; 7/16; 1/2; 9/16; 19/32; 5/8; 11/16; 3/4; 13/16; 7/8; 15/16
8150RN-1/2	○	○ 1/2"	○ 1/2" - 267 mm
8160-1/2	○	○ 1/2"	○ 1/2" - 125 mm
8162-1/2	○	○ 1/2"	○ 1/2" - 250 mm
8166-1/2	○	○ 1/2"	○ 1/2" - 72 mm

FF1E2203

Sada nástrčných klíčů 1/2"

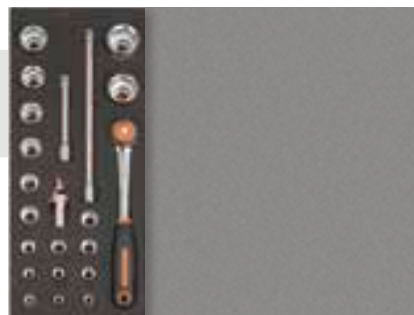

	1/3	2/3	3/3
7800SM	○	○ 1/2"	○ 8-9-10-11-12-13-15-16-17-18-19-20-21-22-24-27-30-32 mm
8150RN-1/2	○	○ 1/2"	○ 1/2" - 267 mm
8160-1/2	○	○ 1/2"	○ 1/2" - 125 mm
8162-1/2	○	○ 1/2"	○ 1/2" - 250 mm
8166-1/2	○	○ 1/2"	○ 1/2" - 72 mm

FF1E2209

Sada nástrčných klíčů 1/2" s bitem

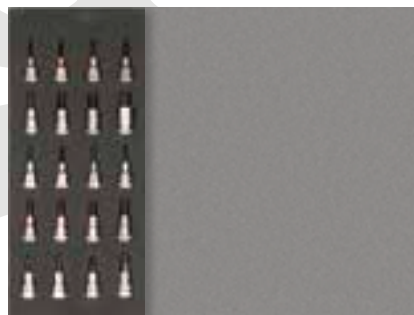

	1/3	2/3	3/3
7809M	●	● 1/2"	● 5-6-7-8-10-12-14-17 mm
7809TORX	●	● 1/2"	● T25-T27-T30-T40-T45-T50-T55-T60
7809XZN	●	● 1/2"	● 6-8-10-12 mm

FF1E3004

Kombinované ráčnové klíče



	1/3	2/3	3/3
1RM			8-9-10-11-12-13-14-15-16-17 mm

1/3 MODULY

FF1E4001

Kleště

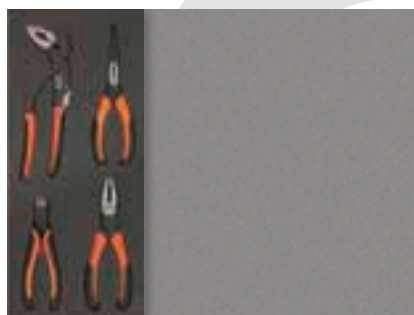

2628 G-180IP	2.5; 2.0	180 mm	
8231 IP	51 mm	225 mm	
2430 G-200 IP		200 mm	
2101G-160IP		160 mm	

FF1E4002

Kleště na pojistné kroužky

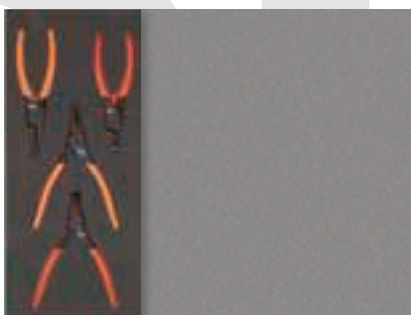

2900-180	180 mm	
2890-180	180 mm	
2990-180	180 mm	
2800-180	180 mm	

FF1E5003

Úderové nářadí

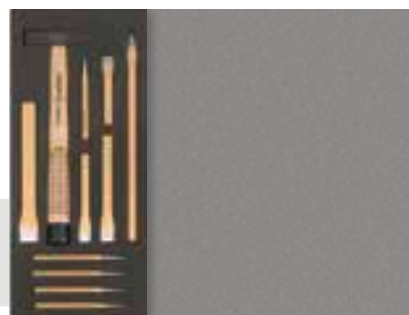

481-300	300 g; 105x300x23 mm	
3735-5-120	120 mm - Ø 5 mm	
3739-300	300 mm	
3740-100	100 mm - 15 mm	
3740-125	125 mm - 15 mm	
3740-150	150 mm - 18 mm	
3740-200	200 mm - 23 mm	
3733	120 mm - Ø 2-4-6 mm	

Pěnové moduly s nářadím: Šité na míru. Zaměřené na uživatele.

Naše systémy pro ukládání nářadí jsou výsledkem našich mnohaletých zkušeností ve spolupráci s jejich uživateli a partnery z letectví a průmyslu – přizpůsobené a navrženy tak, aby usnadnily každodenní práci.

- Pasují do všech mobilních dílenských vozíků Bahco a pracovních stolů Bahco
- Velký výběr modulů



Konfigurator BETMS

bahco.com/cz_cs/betms



Odolné vůči: voda, skydrol, benzin



Odolné vůči ÚV záření



Tlumič nárazů



100 % kontrola 2-barevná pěna



Systém zatlačení (Push)

1/3

181 x 445 mm

2/3

362 x 445 mm

3/3

543 x 445 mm

2/3 MODULY FIT&GO

FF1F1003

Šroubováky ERGO™ pro šrouby s rovnou a Phillips drážkou

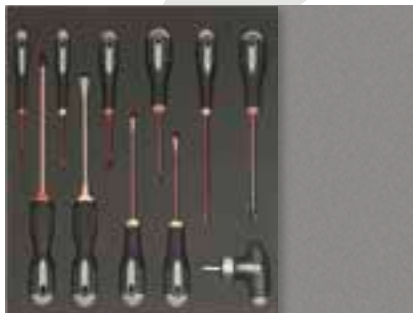

	1/3	2/3	3/3
BE-8030	⊕	⊕	⊕
BE-8242	⊕	⊕	⊕
BE-8252	⊕	⊕	⊕
BE-8155	⊕	⊕	⊕
BE-8870	⊕	⊕	⊕
BE-8600	⊕	⊕	⊕
BE-8610	⊕	⊕	⊕
BE-8620	⊕	⊕	⊕
BE-8623	⊕	⊕	⊕
BE-8624	⊕	⊕	⊕
808050TS	⊕	⊕	⊕

901T	⊕	T10x153; T15x186; T20x186; T25x196; T27x196; T30x245; T40x245
7800SM	⊕	1/2" ⊕ 10-12-13-17-18-19-20-21-22-24-27-30-32 mm
7800DM	⊕	1/2" ⊕ 10-11-12-13-14-15-16-17-18-19 mm
7809M	⊕	1/2" ⊕ 5-6-7-8-10-12 mm
8150SL	⊕	1/2" ⊕ 1/2" - ⊕ 265 mm
8160-1/2	⊕	1/2" ⊕ 1/2" - ⊕ 125 mm
8162-1/2	⊕	1/2" ⊕ 1/2" - ⊕ 250 mm
8166-1/2	⊕	1/2" ⊕ 1/2" - ⊕ 72 mm
8154-1/2	⊕	1/2" ⊕ 1/2" - ⊕ 283 mm
8165-1/2	⊕	1/2" ⊕ 3/8" - ⊕ 37 mm

FF1F3003

Kombinované standardní klíče a ráčnové klíče

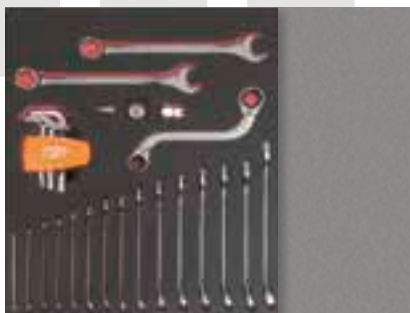

	1/3	2/3	3/3
111M	⊕	⊕	⊕
1320SRM-14-19	⊕	⊕	⊕
1RMA-19-1/2-SQ2	⊕	⊕	⊕
1RMA-19-1/4-SQ	⊕	⊕	⊕
1RMA-13-10-BIT	⊕	⊕	⊕
BE-9778	⊕	⊕	⊕

FF1F3005

Kombinované ráčnové klíče

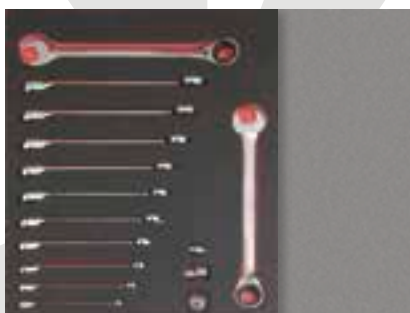

1RM	⊕	8-10-12-13-14-15-16-17-18-19-21-22 mm
1RMA-13-10-BIT	⊕	⊕ 10 mm - ⊕ 13 mm
1RMA-19-1/2-SQ2	⊕	⊕ 1/2" - ⊕ 19 mm
1RMA-19-1/4-SQ	⊕	⊕ 1/4" - ⊕ 19 mm

FF1F1004

Šroubováky ERGO™ pro šrouby s drážkou TORX®

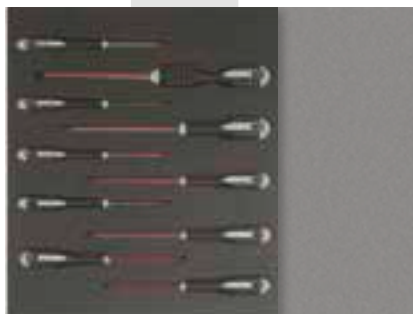

BE-8904	⊕	⊕ T4 x75
BE-8907	⊕	⊕ T7 x75
BE-8908	⊕	⊕ T8 x75
BE-7910	⊕	⊕ TR10 x75
BE-7915	⊕	⊕ TR15 x100
BE-7920	⊕	⊕ TR20 x100
BE-7925	⊕	⊕ TR25 x125
BE-7927	⊕	⊕ TR27 x125
BE-7930	⊕	⊕ TR30 x150
BE-7940	⊕	⊕ TR40 x150

FF1F1007

Šroubováky pro šrouby s drážkou TORX® s T-rukojetí

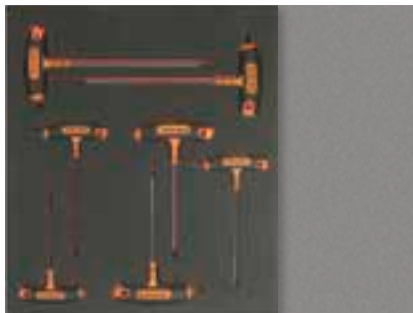

FF1F3008

Oboustranné klíče s vykyvnými hlavami

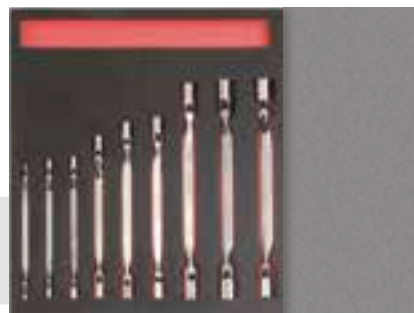

	1/3	2/3	3/3
4040M	⊕	⊕	⊕

FF1F4002

Kleště, nůžky, přidržovací a nastavitelné kleště

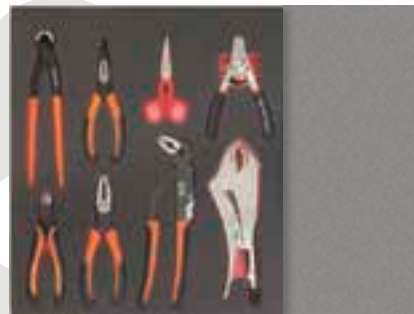

	1/3	2/3	3/3
2928-160	⊕	⊕	⊕
2951-180	⊕	⊕	⊕
SC127	⊕	⊕	⊕
2101G-160IP	⊕	⊕	⊕
2430 G-160 IP	⊕	⊕	⊕
2339 DIP	⊕	⊕	⊕
2628 G-180IP	⊕	⊕	⊕
8224 IP	⊕	⊕	⊕

FF1F4004

Kleště na pojistné kroužky

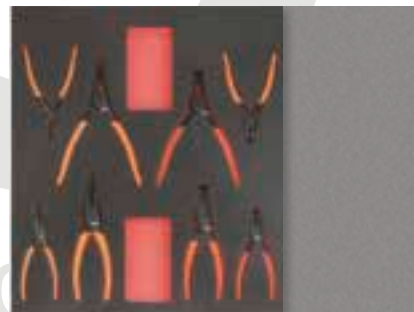

	1/3	2/3	3/3
2800-140	⊕	⊕	⊕
2800-180	⊕	⊕	⊕
2890-140	⊕	⊕	⊕
2890-180	⊕	⊕	⊕
2900-140	⊕	⊕	⊕
2900-180	⊕	⊕	⊕
2990-140	⊕	⊕	⊕
2990-180	⊕	⊕	⊕

3/3 MODULY

Fit & go SYSTEM

BAHCO

FF1F4005

Izolované kleště a kleště s posuvným kloubem

5

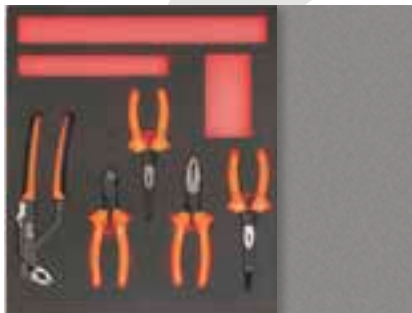

1/3 2/3 3/3

2101S-160	1,000 V -	160 mm	
2430 S-200	1,000 V -	200 mm	
2427 S-200	1,000 V -	200 mm	
8224 IP		250 mm	
2628 S-180	1,000 V -	180 mm	

FF1F5001

Pilníky, kleště, měřicí pásmo

10

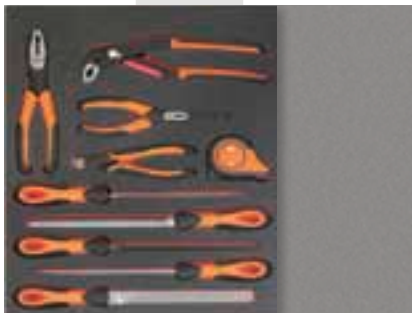

1/3 2/3 3/3

1-100-08-1-2		150 mm-8"	
1-160-08-1-2		150 mm-8"	
1-170-08-1-2		200 mm-8"	
1-210-08-1-2		200 mm-8"	
1-230-08-1-2		200 mm-8"	
2430 G-200 IP		200 mm	
2628G-200IP		3.0; 2.5 - 200 mm	
7224		250 mm	
2101G-160IP		160 mm	
MTB-3-16		3 m - 16 mm	

FF1A1005

Šroubováky, bity, imbusové klíče

66



1/3 2/3 3/3

59S/31-1		1/4": PH1-PH2-PH3-PH2G; T25-T15-T20-T10-T27-T30; H3-H4-H5-H6; PZ1-PZ2-PZ3; 0.8x5.5-0.6x4.5-0.5x3.0; KM653-QR	
BE-8020		0.5 x 3.0 x 60	
BE-8240		0.8 x 4.0 x 175	
BE-8250		1.0 x 5.5 x 150	
BE-8255		1.2 x 6.5 x 150	
BE-8865		1.6 x 8.0 x 175	
BE-8602		PH2 x 25	
BE-8611		PH1 x 75	
BE-8621		PH2 x 100	
BE-8630		PH3 x 150	
BE-9585		T9-T10-T15-T20-T25-T27-T30-T40	
BE-8800		PZ0 x 60	
BE-8811		PZ1 x 75	
BE-8821		PZ2 x 100	
BE-8802		PZ2 x 25	
BE-8830		PZ3 x 150	
BE-8910		T10 x 75	
BE-8915		T15 x 100	
BE-8920		T20 x 100	
BE-8925		T25 x 125	
BE-9678		1.5-2-2.5-3-4-5-6-8-10 mm	

FF1A3004

Kombinované klíče a kombinované ráčnové klíče

30



1/3 2/3 3/3

111M		6-7-8-9-10-11-12-13-14-15-16-17-18-19-20-21-22-24 mm	
1RM		8-9-10-11-12-13-14-15-16-17-18-19 mm	

Kompletní sortiment modulů s náradím najdete - v online Bahco katalogu:



Vybavte si vaše dílenské vozíky náradím. Na výběr máme z více než **200 modulů** s různým náradím v různých velikostech modulů 1/3, 2/3 a 3/3.

1/3

181 x 445 mm

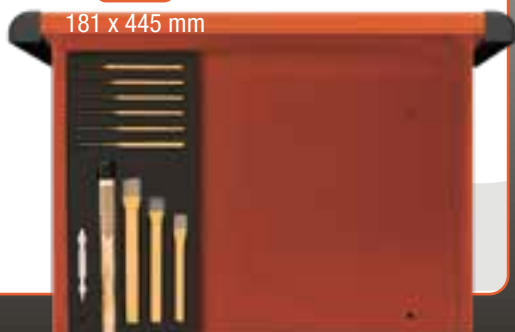

2/3

362 x 445 mm



3/3

543 x 445 mm

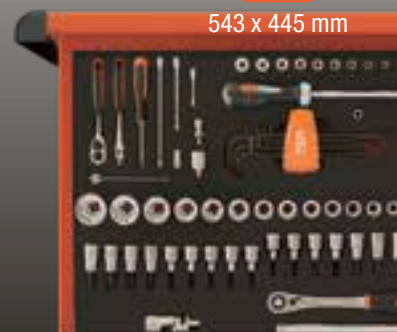

DÍLENSKÉ VOZÍKY



Protiskluzová pryžová pracovní plocha



Plně vysouvateľné zásuvky



Vysoká nosnost



Ochrana rohů



Ø125 x 36 mm



Centrální zamykání s trubkovým klíčem



Řada 1472K Díleňský vozík, prázdný

Řada 1482K Nástavba k díleňským vozíkům, bez nářadí

- Vysoká stabilita díky dvoustěnnému vyztuženému rámu
- Ochrana zásuvky před vypadnutím nářadí



1482K	510 mm	385 mm	690 mm
1472K	510 mm	950 mm	690 mm

Standardní RAL-barvy





71 kg



1472K5

Vnitřní rozměry zásuvek:
(1x) 543 x 445 x 53 mm
(2x) 543 x 445 x 118 mm
(2x) 543 x 445 x 184 mm



75 kg



1472K6

Vnitřní rozměry zásuvek:
(3x) 543 x 445 x 53 mm
(2x) 543 x 445 x 118 mm
(1x) 543 x 445 x 249 mm



78 kg



1472K7

Vnitřní rozměry zásuvek:
(5x) 543 x 445 x 53 mm
(1x) 543 x 445 x 118 mm
(1x) 543 x 445 x 249 mm



79 kg



1472K8

Vnitřní rozměry zásuvek:
(6x) 543 x 445 x 53 mm
(1x) 543 x 445 x 118 mm
(1x) 543 x 445 x 184 mm

Kód výrobku	Zásuvky	Barva		
1472K5	5	Oranžová		RAL 2009
1472K5BLACK	5	Černá		RAL 9005
1472K5BLUE	5	Modrá		RAL 5002
1472K5RED	5	Červená		RAL 3001
1472K5GREY	5	Šedá		RAL 9022
1472K5WHITE	5	Bílá		RAL 9003
1472K6	6	Oranžová		RAL 2009
1472K6BLACK	6	Černá		RAL 9005
1472K6BLUE	6	Modrá		RAL 5002
1472K6RED	6	Červená		RAL 3001
1472K6GREY	6	Šedá		RAL 9022
1472K6WHITE	6	Bílá		RAL 9003

Kód výrobku	Zásuvky	Barva		
1472K7	7	Oranžová		RAL 2009
1472K7BLACK	7	Černá		RAL 9005
1472K7BLUE	7	Modrá		RAL 5002
1472K7RED	7	Červená		RAL 3001
1472K7GREY	7	Šedá		RAL 9022
1472K7WHITE	7	Bílá		RAL 9003
1472K8	8	Oranžová		RAL 2009
1472K8BLACK	8	Černá		RAL 9005
1472K8BLUE	8	Modrá		RAL 5002
1472K8RED	8	Červená		RAL 3001
1472K8GREY	8	Šedá		RAL 9022
1472K8WHITE	8	Bílá		RAL 9003

Nástavba, prázdná

1482K4



Vnitřní rozměry zásuvek:
(3x) 543 x 445 x 53 mm
(1x) 543 x 445 x 118 mm



Kód výrobku	Zásuvky	Barva		
1482K4	4	Oranžová		RAL 2009
1482K4BLACK	4	Černá		RAL 9005
1482K4BLUE	4	Modrá		RAL 5002
1482K4RED	4	Červená		RAL 3001
1482K4GREY	4	Šedá		RAL 9022
1482K4WHITE	4	Bílá		RAL 9003

Příslušenství pro řadu 1472K / 1482K



Kód výrobku	Popis
1477K-AC18	Držák rolny papíru
1477K-AC19	Boční příhrádka
1477K-AC20	Držák pro spreje, plechovky

Kód výrobku	Popis
1477K-AC21	Držák pro pneumatické nářadí
1477K-AC22	Perforovaná boční stěna
1470KAC01	Protiskluzová podložka pro zásuvky

DÍLENSKÉ VOZÍKY

Řada 1475K, 1485K

Díleňský vozík a
nástavba, prázdné

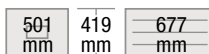
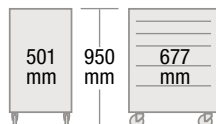

Protiskluzová
pryžová pracov-
ní plocha



Úchyty zásuvek z
hliníkového profilu



Plně vysouva-
telné zásuvky



Ø 125 x 30 mm



57
kg

6

1475K6

Vnitřní rozměry zásuvek:
(6x) 543 x 445 x 53 mm
(1x) 543 x 445 x 118 mm
(1x) 543 x 445 x 184 mm



60
kg

7

1475K7

Vnitřní rozměry zásuvek:
(6x) 543 x 445 x 53 mm
(1x) 543 x 445 x 118 mm
(1x) 543 x 445 x 184 mm



62
kg

8

1475K8

Vnitřní rozměry zásuvek:
(6x) 543 x 445 x 53 mm
(1x) 543 x 445 x 118 mm
(1x) 543 x 445 x 184 mm



Vysoká
nosnost









40
kg

4

1485K4

Nástavba se 4 zásuvkami
Vnitřní rozměry zásuvek:
(3x) 543 x 445 x 53 mm
(1x) 543 x 445 x 118 mm

Kód výrobku	Popis	Barva
1475K6	6	Oranžová  RAL 2009
1475K6BLACK	6	Černá  RAL 9005
1475K6BLUE	6	Modrá  RAL 5002
1475K6RED	6	Červená  RAL 3001
1475K7	7	Oranžová  RAL 2009
1475K7BLACK	7	Černá  RAL 9005
1475K7BLUE	7	Modrá  RAL 5002
1475K7RED	7	Červená  RAL 3001

Kód výrobku	Popis	Barva
1475K8	8	Oranžová  RAL 2009
1475K8BLACK	8	Černá  RAL 9005
1475K8BLUE	8	Modrá  RAL 5002
1475K8RED	8	Červená  RAL 3001
1485K4	4 – Nástavba	Oranžová  RAL 2009
1485K4BLACK	4 – Nástavba	Černá  RAL 9005
1485K4BLUE	4 – Nástavba	Modrá  RAL 5002
1485K4RED	4 – Nástavba	Červená  RAL 3001

Standardní RAL-barvy



Držáky na
přenášení na
obou stranách

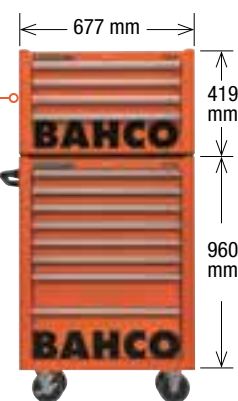

Díleňský vozík
1475K8 s
nástavbou
1485K4

DÍLENSKÉ VOZÍKY

Řada 1475KXL Díleňský vozík XL

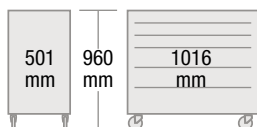

1016 mm



Protiskluzová
pryžová pracov-
ní plocha



Úchyty zásuvek z
hliníkového profilu



Plně vysouva-
telné zásuvky



BAHCO

Ø 125x50 mm STOP

1475KXL6

Díleňský vozík XL se 6 zásuvkami

Vnitřní rozměry zásuvek:
(2x) 881 x 445 x 53 mm
(3x) 881 x 445 x 118 mm
(1x) 881 x 445 x 184 mm



Vysoká
nosnost



116
kg

Kód výrobku	Zásuvky	Barva
1475KXL6	6	Orange  RAL 2009
1475KXL6BLACK	6	Černá  RAL 9005
1475KXL6BLUE	6	Modrá  RAL 5002
1475KXL6RED	6	Červená  RAL 3002



Ø 125 x 50 mm

1475KXL6C

Díleňský vozík XL se 6 zásuvkami a boční skříňkou

Vnitřní rozměry zásuvek:
(3x) 543 x 445 x 53 mm
(2x) 543 x 445 x 118 mm
(1x) 543 x 445 x 249 mm



Vysoká
nosnost



118
kg

Kód výrobku	Zásuvky	Barva
1475KXL6C	6	Oranžová  RAL 2009
1475KXL6CBLACK	6	Černá  RAL 9005



Ø 125x50 mm

1475KXL12

Díleňský vozík XL s 12 zásuvkami

Vnitřní rozměry zásuvek
(1x) 881 x 445 x 53 mm
Zásuvky na levé straně
(4x) 284 x 445 x 53 mm
(1x) 284 x 445 x 118 mm
(1x) 284 x 445 x 184 mm

Zásuvky na pravé straně
(2x) 540 x 445 x 53 mm
(2x) 540 x 445 x 118 mm
(1x) 540 x 445 x 184 mm



Vysoká
nosnost



127
kg

Kód výrobku	Zásuvky	Barva
1475KXL12	12	Oranžová  RAL 2009
1475KXL12BLACK	12	Černá  RAL 9005

DÍLENSKÉ VOZÍKY

Pracovní desky pro řadu 1475K a 1470K

■ Vhodné pro 26" díleňské vozíky 1475K a 1470KSS nebo 40" díleňské vozíky 1475KXL



1470K-ACTSS

26" Pracovní deska z nerezové oceli



1470KXL-ACTSS

40" Pracovní deska z nerezové oceli

1470K-ACTW

26" Pracovní deska ze dřeva

1470KXL-ACTW

40" Pracovní deska ze dřeva



1470K-ACTD

26" Pracovní deska z MDF

1470KXL-ACTD

40" Pracovní deska z MDF



1470K-AC7

26" Pracovní deska z plastu s přihrádkami na malé části

Kód výrobku	Popis
1470K-ACTSS	26" Pracovní deska z nerezové oceli
1470KXL-ACTSS	40" Pracovní deska z nerezové oceli
1470K-ACTW	26" Pracovní deska ze dřeva
1470KXL-ACTW	40" Pracovní deska ze dřeva

Kód výrobku	Popis
1470K-ACTD	26" Pracovní deska z MDF
1470KXL-ACTD	40" Pracovní deska z MDF
1470K-AC7	26" Pracovní deska z plastu

Příslušenství pro řadu 1475K / 1470K



1470K-AC1

Boční polička



1470K-AC2

Držák různého nářadí



1470K-ACSIDE

Perforovaná boční stěna



1470K-AC3

Držák pro spreje, plechovky



1470K-AC4

Boční přihrádka



1470KAC01

Protiskuzová podložka pro zásuvky



1470K-AC8

Perforovaný panel na nářadí

Kód výrobku	Popis
1470K-AC1	Boční polička
1470K-AC2	Držák různého nářadí
1470K-AC3	Držák pro spreje, plechovky
1470K-AC4	Boční přihrádka

Kód výrobku	Popis
1470K-ACSIDE	Perforovaná boční stěna
1470K-AC8	Perforovaný panel na nářadí oranžový
1470KAC01	Protiskuzová podložka pro zásuvky



DÍLENSKÉ VOZÍKY S NÁŘADÍM

1472K6BKFF7SD

Díleňský vozík se 6 zásuvkami se 214 kusy nářadí

■ 3/3 moduly nářadí 543 x 445 mm

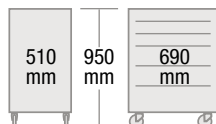
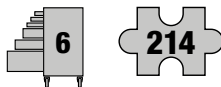

FF1A81



Šroubováky & Klíče



B191.040.100	⌀ 4.0x0.8x100	
B190.055.125	⌀ 5.5x1.2x125	
B190.065.150	⌀ 6.5x1x150	
B192.000.075	PH0x75	
B192.001.100	PH1x100	
B192.002.125	PH2x125	
111M	6-7-8-9-10-11-12-13-14-15-16-17-19-21-22-24mm	
BE-9770-B	1.5-2-2.5-3-4-5-6-8-10 mm	

FF1A82



Úderové nářadí & Kleště



3734S/6-T	⌀ 2-3-4-5-6-8 mm; 150 mm	
479-16	450 g	
3625W-35	⌀ 35 mm	
MTG-3-16	3 m; 16 mm	
KB18-01	18x161 mm	
KSBG18-10 DISPEN	18 mm, x10	

2101G180	180 mm	
2678G-180	2.0; 1.4; 180 mm	
2470G-200	200 mm	
2530	350 mm	
8224	250 mm	

FF1A179

Nástrčné klíče s příslušenstvím



1/4" + 1/2"



2058-BR	1/4", 8 mm	
59/S100B-T	1/4": 4.5-5.5; PH1(x2)-PH2(x9)-PH3-PH2G(x5); PZ1(x2)-PZ2(x9)-PZ3, T10(x3)-T15(x5)-T20(x15)-T25(x8)-T27-T30(x15)-T40(x3)-TR10-TR15-TR20-TR25-TR30; HEX3-HEX4(x3)-HEX5-HEX6(x3)-HEX8; R1-R2	
6950SL	1/4"; 1/4"; 120 mm	
8150SL	1/2"; 1/2"; 265 mm	
6700SM	1/4"; 4-4.5-5-5.5-6-7-8-9-10-11-12-13-14 mm	
A6800DM	1/4"; 7-8-9-10-11-13 mm	
6956	1/4"; 1/4"; 150 mm	
6961	1/4"; 1/4"; 100 mm	
6966	1/4"; 1/4"; 35 mm	

7800SM	1/2"; 10-11-12-13-14-15-16-17-18-19-20-21-22-24-27-30-34 mm	
7805DM	1/2"; 10-13-17-18-19-16-21-22 mm	
7805SM	1/2"; 16-21 mm	
8160-1/2	1/2"; 1/2"; 125 mm	
8162-1/2	1/2"; 1/2"; 250 mm	
8166-1/2	1/2"; 1/2"; 72 mm	
8156-1/2	1/2"; 1/2"; 257 mm	
7106S0080	1/2"; 5/16"	
6973	1/4"; 1/4"	
70S	5/16"; T45-T50-T55	

DÍLENSKÉ VOZÍKY S NÁŘADÍM

1472K6/S1

Díleňský vozík se 6 zásuvkami se 177 kusy nářadí

■ 3/3 moduly nářadí 543 x 445 mm

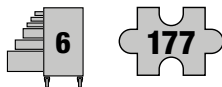

FF1A04

Klíče



S4RM	8-11-12-15-16-19 mm	
111M	6-7-8-9-10-11-12-13-14-15-16-17-18-19-21-22-24-27-32 mm	
6M	6-7-8-9-10-11-12-13-14-15-17-19 mm	
9071C	27 mm; 208 mm / 8"	

FF1A05

Nástrčné klíče s příslušenstvím



BE-9678	1.5-2-2.5-3-4-5-6-8-10 mm	
SBS60	1/4" 4-4.5-5-5.5-6-7-8-9-10-11-12-13-14 mm	
SBS61	1/4" - 145 mm	
SBS63-2	1/4" - 150 mm	
SBS63-4	1/4" - 100 mm	
SBS63-6	1/4" - 150 mm	
SBS64	1/4" 1/4" - 125 mm	
SBS65	1/4" 1/4" - 32.5 mm	
SBS67	1/4" - 153 mm	
SBS69	1/4" 3/8" - 25 mm	
SBS80	1/2" 10-11-12-13-14-15-16-17-18-19-21-22-24-27-30-32 mm	
SBS88	1/2" 3/8" - 37 mm	

59S/31-1	1/4": PH1-PH2-PH3-PH2G; T25-T15-T20-T10-T27-T30; H3-H4-H5-H6; P21-P22-P23; 0.8x6.5-0.6x4.5-0.5x3.0; KM653-QR	
6956	1/4" 1/4" - 150 mm	
6972H	1/4" 1/4" - 26 mm	
7809M	1/2" - 5-6-7-8-10-12-14-17-19 mm	
7809TORX	1/2" - T20-T25-T27-T30-T40-T45-T50-T55-T60	
808050	1/4" 1/2" - 125 mm	
8150SL	1/2" 1/2" - 265 mm	
8154-1/2	1/2" 283 mm	
8160-W	1/2" 1/2" - 125 mm	
8162-1/2	1/2" 1/2" - 250 mm	
8166-1/2	1/2" 1/2" - 72 mm	

FF1A06

Šroubováky a kleště



BE-8020L	0.5 x 3.0 x 75	
BE-8040	0.8 x 4.0 x 100	
BE-8150	1.0 x 5.5 x 100	
BE-8255	1.2 x 6.5 x 150	
BE-8256	1.6 x 8.0 x 150	
BE-8350	1.0 x 5.5 x 25	
BE-8601	PH1 x 25	
BE-8610	PH1 x 75	
BE-8620	PH2 x 100	
BE-8910	T10 x 75	
BE-8915	T15 x 100	
BE-8920	T20 x 100	
BE-8925	T25 x 125	
BE-8927	T27 x 125	
BE-8930	T30 x 150	

MTB-3-16	3 m; 16 mm	
2101B-160IP	160 mm	
2427 G-200 IP	200 mm	
2535L	20 mm	
2628 G-160IP	1.8; 2.0; 160 mm	
2951-180	2.0; 180 mm	
5515T-52	30 mm; 180-690 mm	
8224 IP	250 mm	

FF1A07

Pilníky, úderové nářadí, pilka na kov



3734N	150 mm - 3-5-6 mm	
3735N-4-120	120 mm - 4 mm	
3740-175	175 mm - 21 mm	
SQZ150003	170 mm	
1-100-08-2-2	200 mm	
1-210-08-2-2	200 mm	
1-230-08-2-2	200 mm	
2744	190 mm	

3625W-35	35 mm; 100x300 mm	
3745-150	150 mm; 6 mm; 17x11 mm	
481-400	400 g; 112x300x25 mm	
782-U	290 mm	
317	432 mm / 17"	

Fit & go SYSTEM
Moduly jsou k dispozici i jednotlivě.

1472K7/S1

Dílenský vozík se 7 zásuvkami se 300 kusy nářadí

■ 3/3 moduly nářadí 543 x 445 mm



Moduly jsou k dispozici i jednotlivě.



FF1A08

Nástrčné klíče s příslušenstvím



1/4"
3/8"
1/2"

A6800DM	1/4"	5.5-6-7-8-9-10-11-12-13 mm	
A7402DM	1/4"	10-11-12-13-14-15-16-17-18-19 mm	
1544		76 mm - 0.03-1.00 mm	
6700SM	1/4"	5.5-6-7-8-9-10-11-12-13 mm	
6709M	1/4"	3-4-5-6-8 mm	
6709PH	1/4"	PH1-PH2-PH3	
6709TORX	1/4"	T8-T9-T10-T15-T20-T25-T27-T30-T40	
6950SL	1/4"	1/4" - 120 mm	
6954	1/4"	1/4" - 115 mm	
6956	1/4"	1/4" - 150 mm	
6958	1/4"	153 mm	
6960	1/4"	50 mm	
6961	1/4"	101 mm	
6962	1/4"	152 mm	
6962L	1/4"	335 mm	
6966	1/4"	1/4" - 35 mm	
6972H	1/4"	1/4" - 26 mm	
7400SM	1/4"	6-7-8-9-10-11-12-13-14-15-16-17-18-19-22 mm	
7407H	1/4"	3/8" - 26 mm	
7409M	3/8"	3-4-5-6-7-8-10 mm	
7409TORX	3/8"	T25-T27-T30-T40-T45-T50	
7750SL	3/8"	3/8" - 205 mm	
7754	3/8"	3/8" - 160 mm	
7758	3/8"	250 mm	
7760	3/8"	75 mm	
7761	3/8"	127 mm	
7762	3/8"	252 mm	
7764	3/8"	1/4" - 24,7 mm	
7765	1/4"	3/8" - 25 mm	
7766	3/8"	3/8" - 51,5 mm	
7800SM	1/2"	10-11-12-13-14-15-16-17-18-19-21-22-24-27-30-32 mm	
7807H	1/4"	1/2" - 38 mm	
7809M	1/2"	5-6-7-8-10-12-14-17-19 mm	
7809TORX	1/2"	T20-T25-T27-T30-T40-T45-T50-T55-T60	
8150SL	1/2"	1/2" - 265 mm	
8154-1/2	1/2"	1/2" - 283 mm	
8160-1/2	1/2"	1/2" - 125 mm	
8162-1/2	1/2"	1/2" - 250 mm	
8164-1/2	3/8"	1/2" - 33 mm	
8165-1/2	1/2"	3/8" - 37 mm	
8166-1/2	1/2"	1/2" - 72 mm	
8964	1/2"	3/4" - 45 mm	

FF1A09

Klíče



111M	6-7-8-9-10-11-12-13-14-15-16-17-18-19-21-22-24-27-30-32 mm	
1320RM	8-9-10-11-12-13 mm	
6M	6-7-8-9-10-11-12-13-14-15-16-17-18-19-20-22-24-27-30-32 mm	
9071C	27 mm; 208 mm / 8"	

FF1A10

Šroubováky a měřicí nářadí



BE-8020L	0.5 x 3.0 x 75	
BE-8030	0.6 x 3.5 x 75	
BE-8155	1.2 x 6.5 x 125	
BE-8260	1.6 x 8.0 x 175	
BE-8350	1.0 x 5.5 x 25	
BE-8601	PH1 x 25	
BE-8602	PH2 x 25	
BE-8610	PH1 x 75	
BE-8620	PH2 x 100	
BE-8630	PH3 x 150	
BE-8910	T10 x 75	
BE-8915	T15 x 100	
BE-8920	T20 x 100	
BE-8925	T25 x 125	
BE-8927	T27 x 125	
BE-8930	T30 x 150	
BE-8940	T40 x 150	
BE-9770	1.5-2-2.5-3-4-5-6-8-10 mm	
MTB-3-16	3 m; 16 mm	
1150-112H/P	235 x 75 x 9	
1177-SCRIBE	70°; 230 mm	
2820EF2	200 mm	
5515T-52	30 mm; 180-690 mm	
59S/31-1	1/4"; PH1-PH2-PH3-PH2G; T25-T15-T20-T10-T27-T30; H3-H4-H5-H6; PZ1-PZ2-PZ3; 0.8x5.5-0.6x4.5-0.5x3.0; KM653-QR	
808050S	1/4"; 68 mm	
2047-0-8-4	100 mm	
2047PR-1-2	PH1-2 x 100 mm	

FF1A12

Řezací a úderové nářadí



FS-8	165 mm	
1-100-06-1-2	150 mm	
1-100-06-2-2	150 mm	
1-160-06-1-2	150 mm	
1-210-06-1-2	150 mm	
1-230-06-1-2	150 mm	
2509	525 mm	
2535F2	10 mm; 535 mm	
3625W-35	35 mm; 100x300 mm	
3734	150 mm - 3-5-8 mm	
3735-4-120	120 mm - 4 mm	
3740-150	150 mm - 18 mm	
3745-150	150 mm - 6 mm	
481-300	300 g; 105x300x23 mm	
481-500	500 g; 118x300x27 mm	
8158-1/2	1/2" - 390 mm	
319	300 mm / 11"	

FF1A11

Kleště



2101GC-125IP	125 mm	
2101GC-160IP	160 mm	
21HDGC-200IP	200 mm	
2427 GC-200IP	200 mm	
2430 GC-200 IP	200 mm	
2628 GC-160IP	2.0; 1.8; 160 mm	
2928	160-200-250 mm	
2951-250	3.0 - 250 mm	
2952-165	165 mm	
8224CIP	250 mm	

NÁŘADÍ Z NEREZOVÉ OCELI



Nářadí z nerezové oceli se používá při pracích v náročném kritickém prostředí, kde nesmí dojít ke korozi. Nářadí vyrobené z běžné oceli může zanechávat částice na šroubech, maticích atd., což následně vede k tvorbě rzi. Použitím nářadí Bahco z nerezové oceli se tomuto riziku lze vyhnout.

Uživatel má přístup k nářadí, aniž by musel opustit čistou místnost, což výrazně zvyšuje produktivitu.

Nerezová ocel hraje důležitou roli v odvětvích jako:

- Potravinářský průmysl
- Letectví a kosmický průmysl
- Zdravotnictví
- Farmaceutický průmysl
- Chemický průmysl
- Auto průmysl
- Všude tam kde je kritická, sterilní výroba, a tam kde je čistá místnost nebo korozivní prostředí

Toto nářadí je vyrobeno z nerezové oceli 420





Rukojeť z nerezové oceli může být připojena na obě strany vozíku



Velmi vysoká nosnost

1016 mm

65 kg



Ø 125x30 mm

121 kg



Ø 125x50 mm

1470K7SS

Dílenský vozík z nerezové oceli se 7 zásuvkami



Vnitřní rozměry zásuvek:
 (5x) 543 x 445 x 53 mm
 (1x) 543 x 445 x 118 mm
 (1x) 543 x 445 x 249 mm

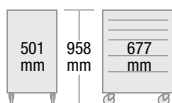

1475KXL7SS

Dílenský vozík z nerezové oceli XL se 7 zásuvkami



Vnitřní rozměry zásuvek:
 (5x) 881 x 445 x 53 mm
 (1x) 881 x 445 x 118 mm
 (1x) 881 x 445 x 249 mm

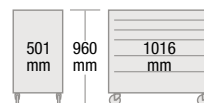

Zásuvky a vodící kolejničky z nerezové oceli, držáky z hliníku

Pro správné uložení nářadí v dílenském vozíku existuje možnost uložení do vložek vyrobených z PMMA Altuglas®. Kontaktujte nás.



NÁŘADÍ Z NEREZOVÉ OCELI



Kombinované klíče z nerezové oceli

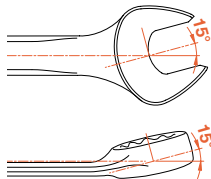

- Podle normy ISO 691
- Vysoká pevnost a tvrdost
- Vynikající odolnost vůči korozi

BAHCO	mm	mm	g
SS002-6	6	105	25
SS002-8	8	120	25
SS002-10	10	120	25
SS002-11	11	135	45
SS002-12	12	135	45
SS002-13	13	150	60
SS002-14	14	150	60
SS002-15	15	175	80
SS002-16	16	175	70
SS002-17	17	195	115
SS002-19	19	195	115
SS002-21	21	195	110
SS002-22	22	215	160
SS002-24	24	215	160
SS002-27	27	215	160



SS002-9-2 Sada kombinovaných klíčů z nerezové oceli

mm 8 10 11 12 13 14 15 17 19



Nastavitelné klíče z nerezové oceli



- Podle normy ISO 6787
- Vysoká pevnost a tvrdost
- Vynikající odolnost vůči korozi

BAHCO	mm	mm	g
SS001-100	13	100	100
SS001-150	18	150	120
SS001-200	24	200	240
SS001-250	30	250	400
SS001-300	36	300	340
SS001-375	46	375	1360
SS001-450	55	450	1840
SS001-600	60	600	3200

BE-9770i Sada zahnutých imbusových klíčů s kuličkou



- pro lepší přístup z nerezové oceli



M 1.5 2 2.5 3 4 5 6 8 10



NÁŘADÍ Z NEREZOVÉ OCELI



BE-9881SL

Sada šroubováků ERGO™ s úzkou čepelí, izolovaných



■ ISO 2380 / DIN 5264



0.5x3.0 mm 1.0x5.5 mm
0.8x4.0 mm 1.2x6.5 mm



PH1
PH2



■ Ergonomická tříšložková rukojeť

Šroubováky ERGO™ z nerezové oceli pro šrouby s drážkou Phillips®



BAHCO	mm	mm	mm
BE-8610i	⊕ PH 1 x 75	27 x 122	197
BE-8620i	⊕ PH 2 x 100	36 x 122	222

Kleště s přesuvným kloubem z nerezové oceli

Rukojeť s povlakem z PVC

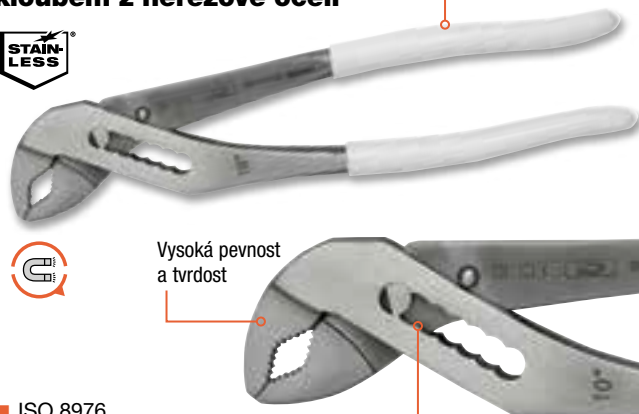

Vysoká pevnost a tvrdost

■ ISO 8976

■ Vynikající odolnost vůči korozi

7 poloh

BAHCO	mm	mm	g
SS410-250	36	250	380
SS410-300	50	300	450

Boční štípací kleště z nerezové oceli



■ ISO 5749

■ Vynikající odolnost vůči korozi

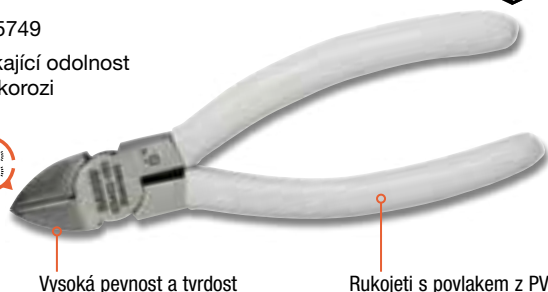

Vysoká pevnost a tvrdost

Rukojeť s povlakem z PVC

BAHCO	mm	CU mm	Fe mm	g
SS402-160	160	0.8*	0.8*	130
SS402-200	195	0.8*	0.8*	335

65I/7-1

Sada bitů z nerezové oceli



● 1/4" DIN 3126-C6.3, ISO 1173



- ⊕ PH2 ⊕ PZ2
- ⊕ T15 T20 T25 T30
- 1/4" ○ 1/4"



NÁŘADÍ PRO PRÁCI VE VÝŠCE

Aby se předešlo nehodám způsobených padajícím nářadím při pracích ve velkých výškách, používá se nářadí s ochranou proti pádu.

Použití takového nářadí zaručuje spolehlivou ochranu před pádem nářadí a tím předchází vážným zraněním, škodám na majetku nebo ztrátě nářadí. Značka Bahco vyvinula nejlepší řešení pro práci ve výškách pro každé nářadí.

Bahco je členem skupiny DROPS (dropped objects prevention scheme), což je průmyslová iniciativa zaměřená na prevenci nehod způsobených padajícími předměty. Všechny naše řešení nářadí jsou schváleny podle směrnic DROPS.



Systém detekce barev na určení maximální nosnosti / hmotnosti



DROPS



Bahco Professionals:
Magnus Strömhall - Climber - YouTube



<https://youtu.be/Ci2F7dLXOLl>

3875-LY5
Závěsné
poutko



Systém detekce barev

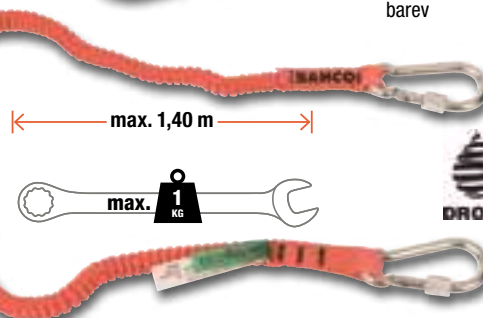

max. 1,40 m

max. 1 KG



DROPS

Očkoploché klíče s bezpečnostní pružinou

■ Vysoce kvalitní legovaná ocel

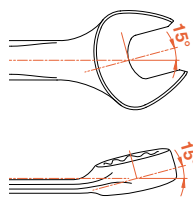

DYNAMIC-DRIVE™

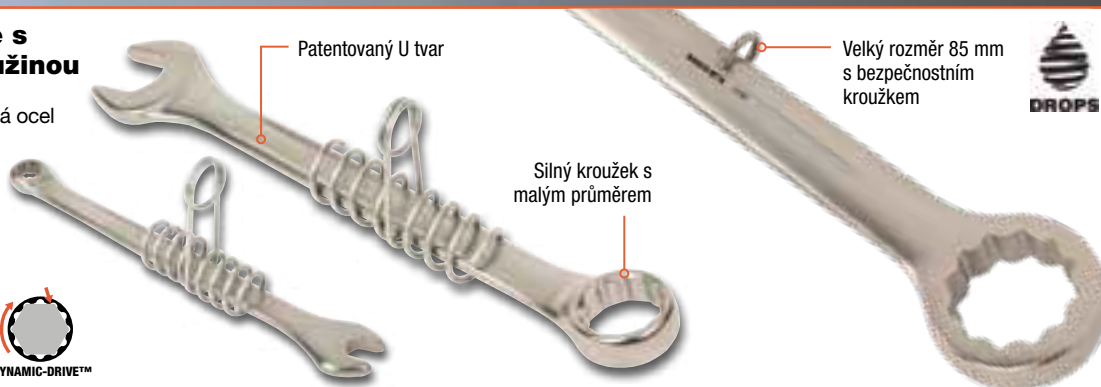

BAHCO	mm	mm	g
TAH111M-6	6	112	30
TAH111M-7	7	120	30
TAH111M-8	8	130	40
TAH111M-9	9	136	40
TAH111M-10	10	144	50
TAH111M-11	11	153	60
TAH111M-12	12	160	70
TAH111M-13	13	165	100
TAH111M-14	14	177	110
TAH111M-15	15	185	120
TAH111M-16	16	195	130
TAH111M-17	17	200	145
TAH111M-18	18	208	170
TAH111M-19	19	215	180
TAH111M-20	20	240	210

BAHCO	mm	mm	g
TAH111M-21	21	250	240
TAH111M-22	22	250	240
TAH111M-23	23	270	310
TAH111M-24	24	270	320
TAH111M-25	25	290	345
TAH111M-27	27	310	470
TAH111M-30	30	330	530
TAH111M-32	32	345	590
TAH111M-34	34	347	570
TAH111M-36	36	400	870
TAH111M-41	41	438	1130
TAH111M-46	46	500	1790
TAH111M-50	50	540	2200
TAH111M-55	55	560	2800
TAH111M-85	85	780	9370

Nastavitelný klíč ERGO™ s bezpečnostní karabinou

ergo®



- Černý povrch, přesně kalené s protikorozní úpravou
- Normy: ISO 9787, DIN 3117, ASME B107.8M - 1996 a BS 6333

BAHCO	mm	mm	mm	g
TAH9070	20	4,9	158	150
TAH9072	31	9	250	500

4750-HDLB-TAH Kožený opasek



- se 6 kroužky na připevnění náradí a jiných předmětů

4750-UP-2 Univerzální pouzdro



4 bezpečnostní kroužky na připevnění lanka

NÁŘADÍ PRO PRÁCI VE VÝŠCE

Boční štípací kleště ERGO™ s bezpečnostním kroužkem

ergo®



BAHCO	mm	Fe+ mm	g
TAH2101G-125	130	1.8	100
TAH2101G-140	145	2.0	140
TAH2101G-160	165	2.5	180
TAH2101G-180	185	2.7	245

Boční štípací kleště ERGO™ pro náročné aplikace s bezpečnostním kroužkem

ergo®



BAHCO	mm	Fe+ mm	g
TAH21HDG-200	210	3.2	270

TAH481 Zámečnické kladivo s bezpečnostní drátěnou smyčkou



BAHCO	mm	g
TAH481	300	360

TAH8224 Stavitelné kleště ERGO™ se závěsným kroužkem



BAHCO	mm	mm	g
TAH8224	45	250	360



KUFRY NA NÁŘADÍ

4750RCHDW02

Nerostbitný odolný kufur z polypropylenu s kolečkami a teleskopickou rukojetí

630 x 480 x 290 mm



-33°C - +90°C

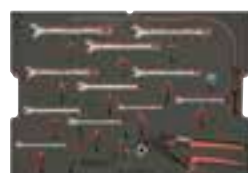
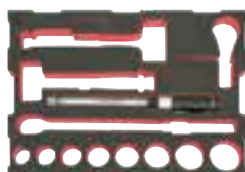

4750RCHDW02FF15

Sada nářadí v odolném kufuru na údržbu větrných turbín

35



4750RCHDW02FF4

Sada nářadí v odolném kufuru na všeobecnou údržbu větrných turbín

113



TAH1177-SCRIBE 230 mm	
TAHBE-8985 Ø + 2 mm	
TAHBE-8020L 0,5x3x7	
TAHBE-8030 0,6x3,5x75	
TAHBE-8155 1,2x6,5x125	
TAHBE-8280 1,6x8,0x175	
TAHBE-8610 PH1x75	
TAHBE-8620 PH2x100	
TAHBE-8630 PH3x150	
TAHBE-8810 PZ1x75	
TAHBE-8820 PZ2x100	
TAHBE-8830 PZ3x150	
TAHBE-8840S 0,8x4,0x100	
TAHBE-8050S 1,0x5,5x125	
BTAHE-8220S 0,5x3,0x100	
TAHBE-8610S PH1x80	
TAHBE-8620S PH2x100	
TAH111M-17 mm	
MTS-5-25 25 mm	
TAH168 1/2" 10, 11, 12, 13, 14, 15, 16, 17, 18, 19, 21, 22, 24, 27, 30, 32 mm	

TAH3625W-35 Ø + 35 mm	
TAH481-300 300 g	
TAH2484-30 300 mm	
TAH37348M-3, 5, 8 mm	
TAH37568M-4 4 mm	
TAH6700SM-1/4" 5, 5, 6, 7, 8, 9, 10, 11, 12, 13 mm	
TAH6950 1/4"	
TAH6956 1/4" 150 mm	
TAH6958 1/4" 153 mm	
TAH6960 1/4" 50 mm	
TAH6961 1/4" 100 mm	
TAH6962 1/4" 150 mm	
TAH6962L 1/4" 355 mm	
TAH6966 1/4" 35 mm	
TAH116 1/2" T40, T45, T50, T55, T60	
TAH150-1/2" 1/2"	
TAH158B-1 1/2" 390 mm	
TAH160 1/2" 125 mm	
TAH162 1/2" 250 mm	
TAH166 1/2" 72 mm	

TAH1-210-06-2-2 150 mm	
TAHE64520 60-160 mm	
TAH452-2 1/2"-5X12	
7452-7-5x12-13, 17, 19 mm	
TAH111M 34, 36, 50 mm	
TAH6070 158 mm	
TAH6072 257 mm	
TAH2620EF2 200 mm	
TAH150-1/2"HP 150 mm	
TAH1544 0,03-0,10 mm	
TAH2335F2 1kg 4, 522 mm	
TAH21010-160 160 mm	
TAH24270-200 200 mm	
TAH2430G-200 200 mm	
TAH26280 160 160 mm	
TAH3CB140G 145 mm	
TAH2509 525 mm	
TAH2224 250 mm	
TAH2047-0,8-4 0,8x4x100	
TAH2047PR-1 2 PH 1-2	
TAH111M 6, 7, 8, 9, 10, 11, 12, 13, 14, 15, 16 mm	

TAHBE-977B 2,5, 3, 4, 5, 6, 8, 10 mm	
TAH111M-18, 19, 21, 22, 24, 27, 30, 32 mm	
TAH1177-SCRIBE 230 mm	
TAHBE-8985 Ø + 2 mm	
TAHBE-8020L 0,5x3x7	
TAHBE-8030 0,6x3,5x75	
TAHBE-8155 1,2x6,5x125	
TAHBE-8280 1,6x8,0x175	
TAHBE-8610 PH1x75	
TAHBE-8620 PH2x100	
TAHBE-8630 PH3x150	
TAHBE-8810 PZ1x75	
TAHBE-8820 PZ2x100	
TAHBE-8830 PZ3x150	
TAHBE-8840S 0,8x4,0x100	
TAHBE-8050S 1,0x5,5x125	
BTAHE-8220S 0,5x3,0x100	
TAHBE-8610S PH1x80	
TAHBE-8620S PH2x100	
TAH111M-17 mm	

TAH3625W-35 Ø + 35 mm	
TAH481-300 300 g	
TAH2484-30 300 mm	
TAH37348M-3, 5, 8 mm	
TAH37568M-4 4 mm	
TAH7000SM-1/4" 5, 5, 6, 7, 8, 9, 10, 11, 12, 13 mm	
TAH6950 1/4"	
TAH6956 1/4" 150 mm	
TAH6958 1/4" 153 mm	
TAH6960 1/4" 50 mm	
TAH6961 1/4" 100 mm	
TAH6962 1/4" 150 mm	
TAH6962L 1/4" 355 mm	
TAH6966 1/4" 35 mm	
MTS-5-25 25 mm	
TAH168 1/2" 10, 11, 12, 13, 14, 15, 16, 17, 18, 19, 21, 22, 24, 27, 30, 32 mm	
TAH16 1/2" T40, T45, T50, T55, T60	
TAH150-1/2" 1/2"	
TAH158B-1 1/2" 390 mm	
TAH160 1/2" 125 mm	
TAH162 1/2" 250 mm	
TAH166 1/2" 72 mm	

NEJISKŘIVÉ NÁŘADÍ

Nejiskřivé nářadí se používá v oblastech, kde se nacházejí hořlavé nebo vysoce hořlavé výpary, kapaliny nebo prach, nebo i v prostředí, kde existuje riziko požáru a výbuchu.

Nejiskřivé nářadí značky Bahco je vyrobeno z hliníkové bronzu nebo měď-berylia, které výrazně snižují riziko vzniku jiskry.



2-složková rukojeť se sklolaminátu

Dílnské kladivo, nejiskřivé

- Sklolaminátová rukojeť
- Hliníkový bronz
- SIN 1401

BAHCO	mm	mm	g	g
NS504-100-FB	280	16	100	220
NS504-200-FB	280	22	200	320
NS504-300-FB	280	23	300	420
NS504-500-FB	310	28	500	700
NS504-800-FB	340	32	800	1030
NS504-1000-FB	960	50	1000	2170
NS504-1500-FB	400	40	1500	1850
NS504-2000-FB	395	45	2000	2270

NS408-250



Rukojeti potažené PVC

Kleště s posuvným kloubem, nejiskřivé

- Hliníkový bronz
- ISO 8976

BAHCO	mm	mm	g
NS408-250	45	250	400

Očkoploché klíče, nejiskřivé

- Hliníkový bronz
- ISO 3113

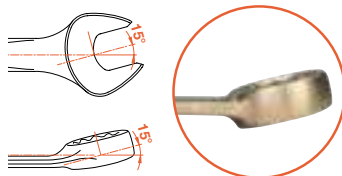

BAHCO	mm	mm	g
NS002-6	6	105	16
NS002-7	7	120	30
NS002-8	8	120	40
NS002-9	9	135	42
NS002-10	10	135	42
NS002-11	11	150	60
NS002-12	12	150	60
NS002-13	13	175	82
NS002-14	14	175	82
NS002-15	15	195	140
NS002-16	16	195	125
NS002-17	17	195	130
NS002-18	18	215	165
NS002-19	19	215	165
NS002-20	20	215	165
NS002-21	21	245	260
NS002-22	22	245	250
NS002-23	23	265	310
NS002-24	24	265	290
NS002-25	25	265	280
NS002-26	26	290	430
NS002-27	27	290	410
NS002-28	28	290	410
NS002-29	29	320	635
NS002-30	30	320	580
NS002-31	31	340	710
NS002-32	32	340	690
NS002-33	33	340	690
NS002-34	34	360	860
NS002-35	35	360	910
NS002-36	36	360	880
NS002-38	38	430	1310
NS002-40	40	430	1190
NS002-41	41	430	1230
NS002-42	42	430	1150
NS002-46	46	480	1590
NS002-50	50	520	1830
NS002-52	52	520	1830
NS002-55	55	560	2270
NS002-60	60	595	2640
NS002-65	65	595	3110
NS002-70	70	630	3730
NS002-75	75	630	3620
NS002-80	80	660	4880



Nastavitelné klíče, nejiskřivé

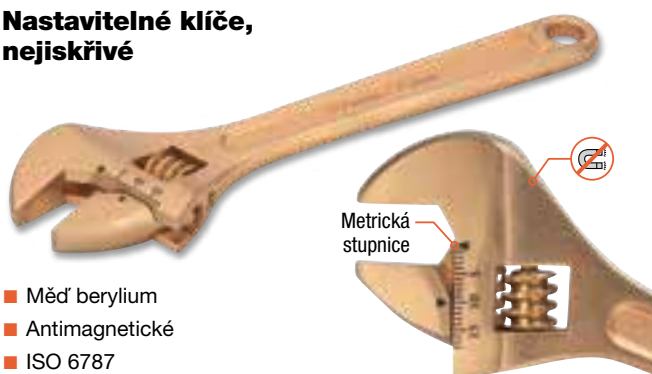

- Měď berylium
- Antimagnetické
- ISO 6787

BAHCO	mm	mm	g
NSB001-150	18	150	135
NSB001-200	24	200	290
NSB001-250	30	250	500
NSB001-300	36	300	830
NSB001-375	48	375	1550
NSB001-450	55	450	2261
NSB001-600	65	600	4990
NSB001-900	75	900	10000

Šroubováky ERGO™ pro šrouby s drážkou Phillips®, nejiskřivé

- Hliníkový bronz
- ISO 8764



BAHCO	mm	mm	g
NS302-0-50	⊕ PH 0 x 50	20 x 122	170
NS302-1-100	⊕ PH 1 x 100	20 x 122	220
NS302-2-125	⊕ PH 2 x 125	27 x 122	250
NS302-3-150	⊕ PH 3 x 150	36 x 122	270
NS302-4-300	⊕ PH 4 x 300	36 x 122	320

IZOLOVANÉ SADY NÁŘADÍ

Veškeré izolované nářadí Bahco se vyrábí podle mezinárodních norem IEC 60900 a je vhodné pro práci na zařízeních pod napětím do 1000 V střídavého a 1500 V stejnosměrného proudu. Podléhá přísným kontrolám kvality a prochází přísnými zkouškami.



IEC 60900  1000 V 

- ▶ Vysoce výkonný a vysoc kvalitní materiál
- ▶ Žádné šíření plamenů
- ▶ Použití při: -20° C až +70° C



Černý konec chrání před nárazy



-  = Bezpečné
-  = Nebezpečné
-  = Vysoké riziko

Pro zajištění bezpečnosti při práci na zařízeních pod napětím se každý jeden kus testuje pod napětím 10 000 voltů po dobu 10 sekund.

6MV/10T

Sada izolovaných vidlicových klíčů

IEC 60900  1000 V 

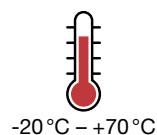

- 3-vrstvý izolační povlak různých barev



 **mm** 10 11 12 13 14 16 17 18 19 22



IEC 60900  1000 V  



7811DMV
Sada izolovaných nástrčných klíčů

11

 1/2"

- 3-vrstvý izolační povlak různých barev*
- Kufřík z nárazuvzdorného plastu

 320 x 300 x 100 mm

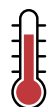

-20°C – +70°C

 10 11 13 17 19 20 22 *	
 1/2" Ráčna*	
 1/2" T-rukojeť *	
 1/2" Prodlužovací nástavec*	
 1.0 x 5.5 x 125	

IEC 60900  1000 V  



3045V-2
Sada izolovaného náradí, pro elektrikáře

19

 1/2"

- 3-vrstvý izolační povlak různých barev*
- Kožený kufřík s kovovými výztuhami

 430 x 260 x 160 mm



-20°C – +70°C

Boční štípací kleště* 160 mm	
Kombinované kleště* 180 mm	
Kleště s kruhovými čelistmi* 160 mm	
Odizolovací kleště* 160 mm	
Vidlicové klíče *	
10 11 12 13 14 17 19 mm	
 0.5x3.0 1.0x5.5	
0.8x4.0 1.2x6.5	
 PH1 PH2	
Elektrikářský nůž*	
Elektrikářské nůžky	

IZOLOVANÉ ŠROUBOVÁKY DO 1000 V

Izolované šroubováky ERGO™ pro šrouby s rovnou drážkou

ergo®

1000 V

Podle IEC 900, DIN EN 60900, VDE 0682 část 201



BAHCO			
BE-8010S	⊖ 0.4 x 2.5 x 75	20 x 122	197
BE-8220S	⊖ 0.5 x 3.0 x 100	20 x 122	222
BE-8230S	⊖ 0.6 x 3.5 x 100	20 x 122	222
BE-8040S	⊖ 0.8 x 4.0 x 100	20 x 122	222
BE-8050S	⊖ 1.0 x 5.5 x 125	27 x 122	247
BE-8065S	⊖ 1.2 x 8.0 x 175	36 x 122	297

Maximální komfort s minimálním úsilím díky ergonomickému designu

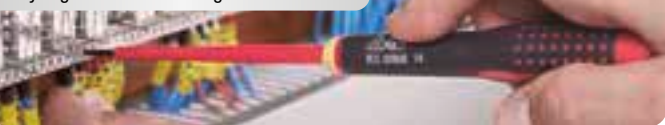

BE-9881SL

Sada šroubováků ERGO™ s úzkou čepelí, izolovaných

ergo® 1000 V

Podle IEC 900, DIN EN 60900, VDE 0682 část 201

ÚZKÁ ČEPEL

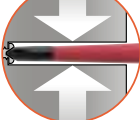

o 30% užší než běžné čepele



5

 0.5 x 3.0 mm 1.0 x 5.5 mm
0.8 x 4.0 mm

 PH1
PH2

Izolované šroubováky ERGO™ pro šrouby s drážkou Phillips®

ergo®

1000 V

Podle IEC 900, DIN EN 60900, VDE 0682 část 201



BAHCO			
BE-8600S	⊕ PH 0 x 75	20 x 122	197
BE-8610S	⊕ PH 1 x 80	27 x 122	202
BE-8620S	⊕ PH 2 x 100	36 x 122	222
BE-8630S	⊕ PH 3 x 150	36 x 122	272

Izolované šroubováky ERGO™ pro šrouby s drážkou Pozidriv®

ergo®

1000 V

Podle IEC 900, DIN EN 60900, VDE 0682 část 201



BAHCO			
BE-8810S	⊕ PZ 1 x 80	27 x 122	202
BE-8820S	⊕ PZ 2 x 100	36 x 122	222
BE-8830S	⊕ PZ 3 x 150	36 x 122	272

Izolované šroubováky ERGO™ pro šrouby s drážkou Torx®

ergo®

1000 V

Podle IEC 900, DIN EN 60900, VDE 0682 část 201



BAHCO			
BE-8908S	⊕ T 8 x 75	20 x 122	197
BE-8909S	⊕ T 9 x 75	20 x 122	197
BE-8910S	⊕ T 10 x 100	20 x 122	222
BE-8915S	⊕ T 15 x 125	27 x 122	247
BE-8920S	⊕ T 20 x 125	27 x 122	247
BE-8925S	⊕ T 25 x 150	27 x 122	272

BE-9876S
Sada XXL izolovaných šroubováků ERGO™

ergo® 1000 V

14



■ Vyrobeno podle normy IEC 900, DIN EN 60900, VDE 0682 část 201

■ Ergonomická 3-složková rukojeť



Kombinovaná drážka
 Křížová drážka PZ1 5 mm
 Křížová drážka PZ2 6 mm



PZ1
 PZ2



PH1
 PH2



T10
 T15
 T20



0.4x2.5 mm 0.8x4.0 mm
 0.5x3.0 mm 1.0x5.5 mm
 0.6x3.5 mm

ÚZKÁ ČEPEL



O 30% užší než běžné čepele

808061 / 808062

Izolovaná rukojeť ráčnových šroubováků se 6 izolovanými vyměnitelnými čepelemi v sadě



100 mm

- Ráčnový mechanismus se 48 zuby pro rychlé utahování
- Dodává se v praktickém pouzdře se 6 dírkami a poutkem na opasek



Nevodivý kroužek, rychlá změna polohy ráčnového mechanismu

1000 V GS

Bahco design: měkká protiskluzová rukojeť pro pohodlné uchopení

Patentované: tlačítko pro uvolnění a výměnu čepele

808061



808062



7

7

BAHCO

808061	⊖	0.4x2.5	0.5x3.0	0.8x4.0	1.0x5.5
	⊕	PH1	PH2		
808062	⊖	0.4x2.5	0.5x3.0	0.8x4.0	1.0x5.5
	⊕	PZ1	PZ2		

MOMENTOVÉ NÁŘADÍ

74WR-

Nastavitelný momentový mechanický klíč s okénkem

- Robustní mechanismus – po více než 100 000 cyklech v toleranci $\pm 3\%$
- Pevná ráčnová hlava

Snadno čitelná
dvojité stupnice

Zvukový a hmatový signalizační
systém při kliknutí



Odolný vůči:
benzín, olej,
hydraulické kapaliny

S otáčením pouze
ve směru doprava

Označení středu rukojeti
pro optimální uchopení

Intervaly
opakování
kalibrace



BAHCO	Nm	mm	mm	g
74WR-15	3–15	1/4"	221	300
74WR-25	5–25	1/4"	221	300

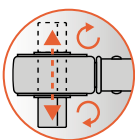

- Průchozí čtyřhran na
změnu směru otáčení



Pohodlný na
dotek příjemný
povrch



Odolný vůči:
benzín, olej,
hydraulické kapaliny



Tlačítko pro nastavení
kroučícího momentu,
zřetelně viditelné při uvolnění

BAHCO	Nm	ft.lb	mm	mm	g
74WR-50	10–50	7.5-37.5	3/8"	335	700
74WR-100	20–100	15-75	1/2"	387	900
74WR-200	40–200	30-150	1/2"	470	1100
74WR-300	60–300	45-220	1/2"	593	1400
74WR-340	60–340	45-250	1/2"	685	1500
74WR-400	80–400	60-300	3/4"	686	1900

74PR- Přednastavený mechanický momentový klíč

- Robustní mechanismus – po více než 100 000 cyklech v toleranci $\pm 3\%$
- Pevná ráčnová hlava



BAHCO	Nm	mm	mm	g	Kč
74PR-20	4–20	1/4"	219	400	2.960



Zvukový a hmatový signalizační systém při kliknutí

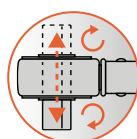

Průchozí čtyřhran na změnu směru otáčení



BAHCO	Nm	mm	mm	g
74PR-60	12–60	3/8"	295	600
74PR-60A	12–60	1/2"	301	700
74PR-100	20–100	3/8"	335	700
74PR-100A	20–100	1/2"	342	700

Barevné kódy koncovky



BAHCO	Nm	mm	mm	g
74PR-200	40–200	1/2"	425	1000
74PR-300	60–300	1/2"	668	1200
74PR-400	80–400	3/4"	675	2000

75R3- Nastavitelný mechanický momentový klíč bez fixního bodu na rukojeti

- Konstantní točivý moment při každé délce páky
- Prodlužovací rukojeť výrazně snižuje úsilí potřebné pro vysoké krouticí momenty
- Pevná ráčnová hlava

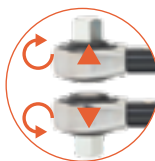

Průchozí čtyřhran na změnu směru otáčení

Zvukový a hmatový signalizační systém při kliknutí



Snadno čitelná dvojitá stupnice



Uzamčení rukojeti



Robustní kovové pouzdro

Prodloužení pro větší výkon



BAHCO	Nm	mm	mm	g
75R3-650*	130–650	3/4"	856	4000
75R3-800	200–800	3/4"	1037	5200
75R3-1000	300–1000	3/4"	1245	5800

* Prodlužovací rukojeť není součástí dodávky, samostatně k dispozici



MOMENTOVÉ NÁŘADÍ

Elektronický momentový klíč s nastavováním úhlu utahování

- Programovatelný čas automatického vypnutí
- Uchování hodnot a nastavení během výměny baterie



- Pevná ráčnová hlava s kloubem, 40 zubů

- LED diody na obou stranách



- Dosažení prahu předběžného varování
- V cílovém rozsahu
- Mimo toleranci

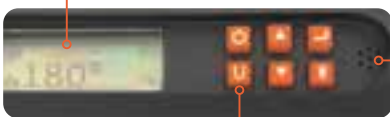

- Nm, Kg.cm., dNm, Lbf.ft., Lbf.in.



Vibrování rukojeti

TAW- Elektronický momentový klíč s nastavováním úhlu utahování

- 50 měření
- 10 přednastavení

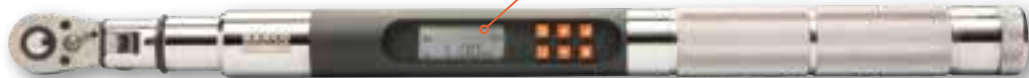
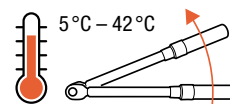

- Provozní režimy:
 - Kroučící moment
 - Úhel
 - Točivý moment a potom úhel
 - Přednastavené hodnoty

BAHCO	Nm	mm	mm	g
TAW38135	7-135	3/8"	475	1270
TAW12340	17-340	1/2"	670	1910
TAW34800	40-800	3/4"	1235	4850

TAWM- Elektronický momentový klíč s nastavováním úhlu utahování s pamětí & USB

- 1500 měření
- 50 přednastavení



- Provozní režimy:
 - Točivý moment
 - Úhel
 - Točivý moment a úhel
 - Točivý moment a potom úhel
 - Přednastavené hodnoty
 - Pracovní režim

BAHCO	Nm	mm	mm	g
TAWM38135	7-135	3/8"	475	1280
TAWM12340	17-340	1/2"	670	1970
TAWM34800	40-800	3/4"	1235	4850

TAWM1412M/TAWM1430M Elektronický Mikro-momentový klíč s nastavením úhlu utahování s pamětí & USB

- 1500 měření
- 50 přednastavení



- Provozní režimy:
 - Točivý moment
 - Úhel
 - Točivý moment a úhel
 - Točivý moment a potom úhel
 - Přednastavené hodnoty
 - Pracovní režim

BAHCO	Nm	mm	mm	g
TAWM1412M	0.6-12	1/4"	292	405
TAWM1430M	1.5-30	1/4"	357	820

TAS14- Elektronický momentový šroubovák

- Odolný a pevný kryt z kompozitního materiálu Tri-Lobe
- Membránová klávesnice s blokovacím tlačítkem, proti náhodnému přenastavení
- Provozní režimy:
 - Točivý moment
 - Úhel
 - Točivý moment a potom úhel



Přídavný držák tvaru L pro větší páku a kontrolu



BAHCO	Nm	cNm	□	○	← mm →	mm	g
TAS14H09	0.45-9	45-900	-	1/4"	189	40	325
TAS14S09	0.45-9	45-900	1/4"	-	189	40	325



89049TM-1000 Násobič točivého momentu

- Vyměnitelné rovné a vyhnuté reakční ramena

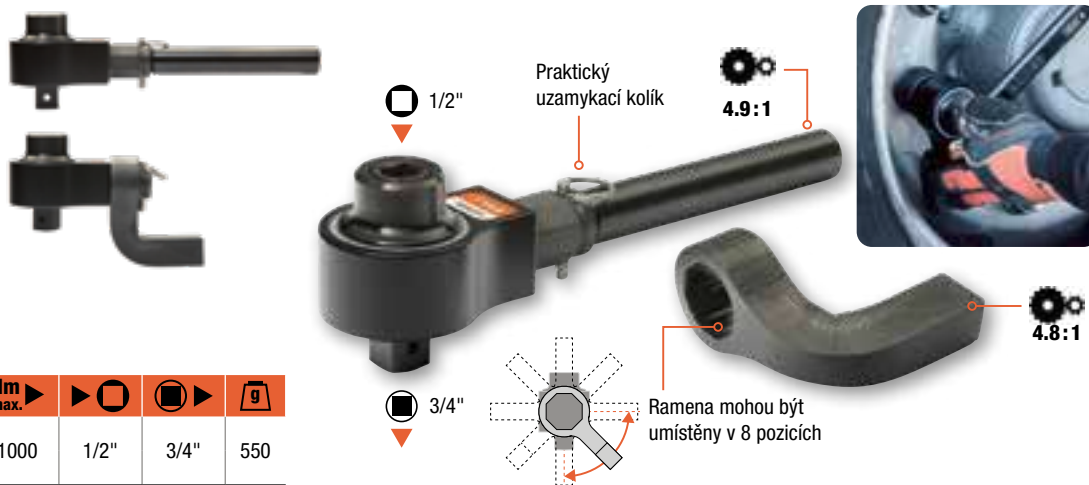

Nm max.	⚙️	Nm max.	▶ ◻ ◻ ▶	◻ ▶	g
204	4.9:1	1000	1/2"	3/4"	550
208	4.8:1				

89222CR/96255CR Kompaktní násobiče točivého momentu

- S vyhnutým reakčním ramenem
- Lehký kompaktní design pro snadný přístup



BAHCO	▶ Nm max.	⚙️	Nm max.	▶ ◻ ◻ ▶	◻ ▶	g
89222CR-1000	45	22.2:1	1000	1/2"	3/4"	1400
9527CR-2000	74	27:1	2000	1/2"	1"	3200
9525CR-4000	160	25:1	4000	1/2"	1"	5400
96255CR-7000	274	25.5:1	7000	1/2"	1 1/2"	9300



AKUMULÁTOROVÉ NÁŘADÍ

Kovové pouzdro
uložení pro delší
životnost a výkon



Všechny sady se dodávají
v plastovém kufru
s 2 akumulátory a nabíječkou

Nový sortiment pro
náročné mechaniky

BCL31IS1K1

Aku Mini rázový šroubovák - sada

1/4"

155 mm

12V

max.
105
Nm



Rychloupínací
sklíčidlo



0.93
kg

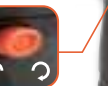
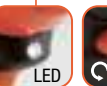

IP20



Video
BCL31IS1



- Kovové pouzdro uložení pro delší životnost a výkon
- Nízké vibrace díky dvousložkové rukojeti



1/4"	V	Max Nm	min ⁻¹	dba	m/sec ⁻²	mm	kg
1/4"	12	105	0-2400	101.1	8.85	155x50x191	0.93

BCL33IW1K1

Aku rázový utahovák - sada

1/2"

18V

2 rychlosti
110 Nm
(550 RPM) + 590 Nm
(1650 RPM)

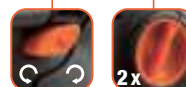

IP20

- Kovové pouzdro uložení pro delší životnost a výkon
- Indikátor stavu akumulátoru se aktivuje vypínačem



1/2"	V	Max Nm	min ⁻¹	dba	m/sec ⁻²	mm	kg
1/2"	18	105 / 590	550 / 0-1650	99.2	6.65	260x70x258	3.11

BCL31D1K1 Aku vrtačka/šroubovák - sada

3/8"-10 mm

12V

Rychloupínací skříčidlo

10 různých nastavení točivého momentu
1 nastavení vrtání

1.03 kg



IP20

2 rychlosti



Nízké vibrace díky dvousložkové rukojeti



mm	V	Max Nm	min-1	dba	m/sec-2	mm	kg
10	12	24	360 / 1550	83.9	4.00	200x54x191	1.03



BCL32G1K1 Aku maznice - sada

14.4V



750 mm



≥ 400 g

414 bar

70g / min.



V	PSI / BAR	g/min.	dba	m/sec-2	mm	kg
14.4	600 / 414	70	78.6	0.39	200x75x485	3.4

BCL33D1K1 Aku vrtačka/šroubovák - sada

1/2"-13 mm

18V

Rychloupínací skříčidlo

10 různých nastavení točivého momentu
1 nastavení vrtání

LED



|||



JEDNOTKA BEZKARTÁČOVÉ MOTORU

- ✓ vysoký točivý moment
- ✓ vyšší frekvence úderů
- ✓ menší údržba
- ✓ delší životnost

2 rychlosti



Nízké vibrace díky dvousložkové rukojeti
Indikátor stavu akumulátoru se aktivuje vypínačem

IP20



mm	V	min-1	Max Nm	dba	mm	kg
13	18	0-370 / 0-1550	32	83.5	180x60x290	1.35



AKUMULÁTOROVÉ NÁŘADÍ

BCL33IW2K1

Aku rázový utahovák - sada



1/2"

18V

max.
1000
Nm

HD

IP20



LED

Indikátor stavu
akumulátoru

JEDNOTKA BEZKARTÁČOVÉHO MOTORU



- ✓ vysoký točivý moment
- ✓ vyšší frekvence úderů
- ✓ menší údržba
- ✓ delší životnost



18.060 Kč

- Vysoká efektivita, vynikající výkon
- Kovové pouzdro uložení pro delší životnost a výkon

1/2"	V	Max Nm	min-1	dba	m/sec ²	mm	kg
1/2"	18	1000	0-1700	100.6	6.37	240x65x360	3.1



AKUMULÁTOROVÉ NÁŘADÍ

BCL33AP1K1

Aku excentrická bruska - sada

∅ 5"/127 mm Velcro®

18V



IP20



m/sec²
2.52

Indikátor stavu akumulátoru



Aretační tlačítko s bezpečnostním vypínačem



• 1100
• 1450
• 2300
• 3050
• 3500
ot./min.

Pravo-/levostranná
přídavná rukojeť pro
lepší ovládnání nářadí

- Dodává se s houbou a vlněným náplekem pro leštění a čištění
- S bezpečnostním vypínačem
- Aretační tlačítko vypínače pro vyšší komfort práce
- Nízké vibrace díky dvousložkové rukojeti



5 Ah

∅ mm	V	∅ mm		min ⁻¹	dba	m/sec ²	mm	kg
127	18	4.7	5/16" 24UNF	1100-3500	82.5	2.52	376x153	1.82

BITY A RÁČNOVÉ ŠROUBOVÁKY

59/S54BC Sada bitů

● 1/4" DIN 3126-C6.3, ISO 1173

54



<25mm>							<125mm>	<150mm>
⊖	⊕	⊕	⊕	⊕	⊕	⊖	⊕	⊕
4.5	PH1	PZ1	T10 x2	TR10	HEX3	R1	PH1	T20
5.5	PH2 x4	PZ2 x4	T15 x2	TR15	HEX4	R2	PH2	T25
	PH3	PZ3	T20 x4	TR20	HEX5			T30
	PH2G x2		T25 x2	TR25	HEX6		⊕	
			T27	TR30	HEX8		PZ1	
			T30 x4				PZ2	
			T40					

BAREVNÉ

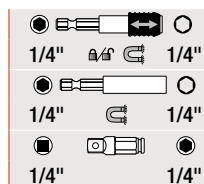
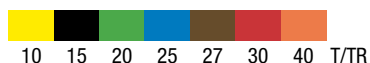

59/S100BC Sada bitů

● 1/4" DIN 3126-C6.3, ISO 1173

100



<25mm>						
⊖	⊕	⊕	⊕	⊕	⊕	⊖
4.5	PH1	PZ1 x2	T10 x3	TR10	HEX3	R1
5.5	PH2 x9	PZ2 x9	T15 x5	TR15	HEX4 x3	R2
	PH3	PZ3	T20 x15	TR20	HEX5	
	PH2G x5		T25 x8	TR25	HEX6 x3	
			T27	TR30	HEX8	
			T30 x15			
			T40 x3			

BAREVNÉ

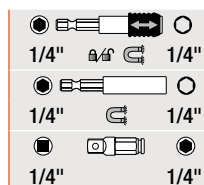
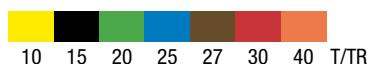

59/S31B Sada bitů

31

● 1/4" DIN 3126-C6.3, ISO 1173



⊖	⊕	⊕	⊕	⊕
4.5	PH1	PZ1	T10	HEX3
5.5	PH2 x3	PZ2 x3	T15 x3	HEX4
	PH3	PZ3	T20 x3	HEX5
	PH2G x2		T25 x2	HEX6
			T27	
			T30	



59S/22-2 Sada bitů

22

● 1/4" DIN 3126-C6.3, ISO 1173

■ V pryžovém držáku

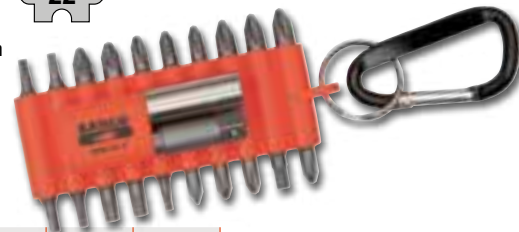

⊕	⊕	⊕	⊕
PH2 x3	PZ2 x2	T10	HEX2.5
PH2G x2	PZ3	T15 x4	HEX3.0
		T20 x3	
		T25 x2	

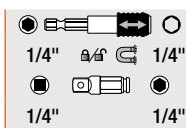

808050P

Ráčnový šroubovák, držák bitů s pistolovou rukojetí

● 1/4" DIN 3126-C6.3, ISO 1173

- Stisknutím tlačítka se rukojeť otočí a zablokuje v poloze 30°
- Se 6 bitů v zásobníku v rukojeti

⊖	⊕	⊕
0.6x4.5	PH1	PZ1
0.8x5.5	PH2	PZ2



808050L

Ráčnový šroubovák, držák bitů s LED osvětlením

● 1/4" DIN 3126-C6.3, ISO 1173

- Se 6 bitů v zásobníku v rukojeti

⊖	⊕	⊕
0.6x4.5	PH1	PZ1
0.8x5.5	PH2	PZ2



808050S

Ráčnový šroubovák, držák bitů, krátký

● 1/4" DIN 3126-C6.3, ISO 1173

- Pro práci ve stísněných prostorech



KM653-QR-1P

Magnetický držák bitů



○	●
1/4"	1/4"

2058/S26

Sada bitů, nástrčných klíčů, ráčnového klíče a adaptérů



- Díky patentovanému 1/4" ráčnovému klíči (US Pat. 6860175) se dají šrouby a matice lehce uvolnit a utáhnout i ve stísněných prostorech

8 mm 1/4"

⊖	⊕	⊕	⊕	●	○
4.0	PH1	PZ1	T10	3	6
5.0	PH2	PZ2	T15	4	7
6.0	PH3	PZ3	T20	5	8
			T25	6	10
			T30		13

1/4" 1/4" 1/4" 1/4"



ŠROUBOVÁKY

Šroubováky ERGO™ pro šrouby s rovnou drážkou

ergo®

- BE-8160 se šestihranem pro použití vidlicového klíče na zvýšení točivého momentu



BAHCO				
BE-8010	⊖ 0.4 x 2.5 x 60	20 x 122	182	-
BE-8030	⊖ 0.6 x 3.5 x 75	20 x 122	197	-
BE-8040	⊖ 0.8 x 4.0 x 100	20 x 122	222	-
BE-8150	⊖ 1 x 5.5 x 100	27 x 122	222	-
BE-8155	⊖ 1.2 x 6.5 x 125	36 x 122	247	-
BE-8160	⊖ 1.6 x 8 x 125	36 x 122	247	14

Šroubováky ERGO™ pro šrouby s drážkou Phillips®

ergo®

- BE-8630 se šestihranem pro použití vidlicového klíče na zvýšení točivého momentu

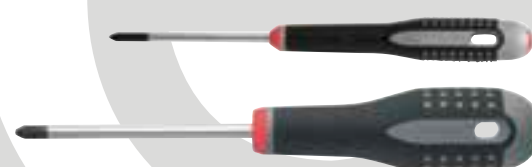

BAHCO				
BE-8600	⊕ PH 0 x 60	20 x 122	182	-
BE-8610	⊕ PH 1 x 75	27 x 122	197	-
BE-8620	⊕ PH 2 x 100	36 x 122	222	-
BE-8630	⊕ PH 3 x 150	36 x 122	272	14

Šroubováky ERGO™ pro šrouby s drážkou Pozidriv®

ergo®

- BE-8830 se šestihranem pro použití vidlicového klíče na zvýšení točivého momentu



BAHCO				
BE-8800	⊕ PZ 0 x 60	20 x 122	182	-
BE-8810	⊕ PZ 1 x 75	27 x 122	197	-
BE-8820	⊕ PZ 2 x 100	36 x 122	222	-
BE-8830	⊕ PZ 3 x 150	36 x 122	272	14



Ergonomické šroubováky Výhody držíte ve své ruce

- 1 Trvalé barevné označení pro výběr správného typu čepce
- 2 Optimální délka rukojeti s rychlou zónou otáčení
- 3 Tříšložková rukojeť: masivní jádro s protiskluzovým povrchem
- 4 Zaoblené hrany zabraňují vzniku tlakových bodů
- 5 Měkký, protiskluzový povrch
- 6 Plochá část zabraňuje kutálení

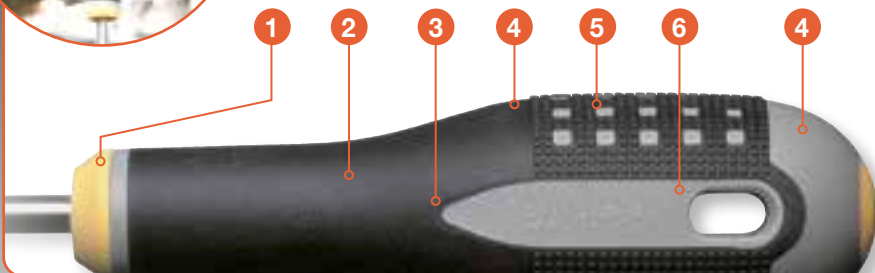

ergo®

Šroubováky ERGO™ pro šrouby s vnitřním šestihranem

ergo®

- Kulový tvar špičky pro lepší přístup

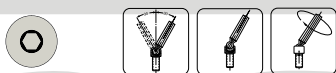

BAHCO	mm	mm	mm
BE-8715	● H 1.5 x 60	20 x 122	182
BE-8702	● H 2 x 100	20 x 122	222
BE-8725	● H 2.5 x 100	20 x 122	222
BE-8703	● H 3 x 100	20 x 122	222
BE-8704	● H 4 x 100	27 x 122	222
BE-8705	● H 5 x 100	36 x 122	222
BE-8706	● H 6 x 125	36 x 122	247
BE-8708	● H 8 x 150	36 x 122	272

Šroubováky ERGO™ pro šrouby s drážkou Torx®

ergo®



BAHCO	mm	mm	mm
BE-8904	⊕ T 4 x 75	20 x 122	197
BE-8905	⊕ T 5 x 75	20 x 122	197
BE-8906	⊕ T 6 x 75	20 x 122	197
BE-8907	⊕ T 7 x 75	20 x 122	197
BE-8908	⊕ T 8 x 75	20 x 122	197
BE-8909	⊕ T 9 x 75	20 x 122	197
BE-8910	⊕ T 10 x 75	20 x 122	197
BE-8915	⊕ T 15 x 100	27 x 122	222
BE-8920	⊕ T 20 x 100	27 x 122	222
BE-8925	⊕ T 25 x 125	27 x 122	247
BE-8930	⊕ T 30 x 150	36 x 122	272

Šroubováky ERGO™ pro šrouby s drážkou Torq-Set®



ergo®



BAHCO	mm	mm	mm
BE-8080-1	⊕ 1 x 75	27 x 122	197
BE-8080-2	⊕ 2 x 75	27 x 122	197
BE-8080-3	⊕ 3 x 75	27 x 122	197
BE-8080-4	⊕ 4 x 75	27 x 122	197
BE-8080-5	⊕ 5 x 75	27 x 122	197
BE-8080-6	⊕ 6 x 75	27 x 122	197
BE-8080-8	⊕ 8 x 100	27 x 122	222
BE-8080-10	⊕ 10 x 100	27 x 122	222

BE-3529 ERGO™ páka s očkem

ergo®

- Na odpojování



BAHCO	mm	mm	mm
BE-3529	3 x 175	20 x 122	175

ŠROUBOVÁKY

BE-9877

Sada XXL šroubováků ERGO™

■ Ergonomická 3-složková rukojeť

ergo®



NOVÉ

15



0.6x3.5x75 mm
1.0x5.5x100 mm



PH1 x75 mm
PH2 x100 mm



PZ1 x75 mm
PZ2 x100 mm



T10x75 mm
T15x100 mm
T20x100 mm
T25x125 mm

**Izolované 1000 V
šroubováky**

Podle IEC 900,
DIN EN 60900,
VDE 0682 část 201

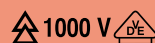

0.5x3.0x100 mm
0.8x4.0x100 mm
1.0x5.5x125 mm



PH1 x80 mm
PH2 x100 mm

Sady šroubováků s T-rukojetí

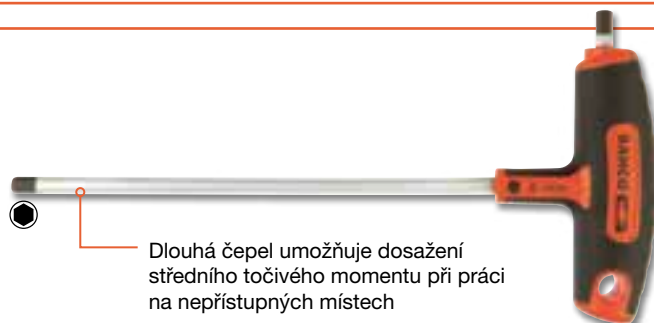

Krátkou 90° čepel je možné používat na šroubování s extrémním utahovacím momentem ve snadno dostupných místech nebo s omezenou výškou



6

BAHCO

903T-1	● Vnitřní šestihran	3, 4, 5, 6, 8, 10 mm
903T-2	★ TORX®	T10, T15, T20, T25, T30, T40
903T-3	○ Šestihran	5, 6, 7, 8, 10, 13 mm



BE-9881TB
Sada šroubováků ERGO™
s průchozí čepelí



ergo®



0.6x3.5x75
0.8x4.5x100
1.0x5.5x100
1.2x6.5x125



PH1 x100
PH2x125

706-5
Sada přesných šroubováků



- Otočná koncová krytka pro rychlé utahování a uvolňování
- Trvalé barevné označení na rychlou identifikaci správného profilu

⊖	⊕	⊕	⊕	⊕	⊕	⊕
1.0	2.0	PH00	PZ0	T6	T10	M 1.5
1.2	3.0	PH0	PZ1	T7	T15	M 2.0
1.5	3.5	PH1	PZ3	T8	T20	M 2.5
1.8	4.0			T9		M 3.0



Zkoušečka napětí do 250 V



8045LVDE se sponou

- Plastová rukojeť odolná vůči nárazům
- V souladu s normou DIN VDE 0680/6 GS-značené

BAHCO	⊖	mm
8045VDE	0.5x3.5	134
8045LVDE	0.5x3.5	170

RÁČNY

Obousměrné ráčny s úzkou hlavou

Tlačítko pro rychlé uvolnění



Páčka pro rychlou změnu směru



6950SL Obousměrná ráčna 1/4"

■ 72 zubů

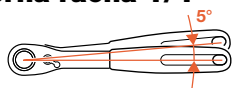

7750SL Obousměrná ráčna 3/8"

■ 72 zubů

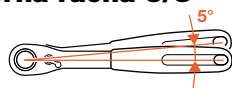

8150SL Obousměrná ráčna 1/2"

■ 72 zubů

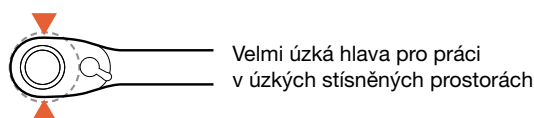
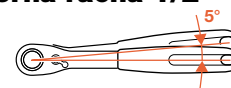

BAHCO	□	∠	← mm →	g
6950SL	1/4"	5°	120	90
7750SL	3/8"	5°	205	200
8150SL	1/2"	5°	265	440

Ráčna s výkyvnou hlavou



■ 72 zubů

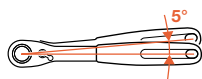

NOVÉ

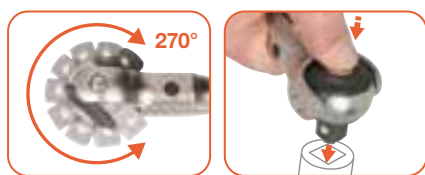

BAHCO	□	∠	← mm →	g
8120-1/4	1/4"	5°	149	129
8120-3/8	3/8"	5°	223	311
8120-1/2	1/2"	5°	266	572



Obousměrné jednoruční ráčny ERGO™ ergo®

7755-3/8 Obousměrná ráčna 3/8"

■ 72 zubů

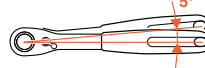

Integrovaný otočný kroužek pro snadnější změnu směru

Tlačítko pro rychlé uvolnění



Rychlé otáčení kroužku

8155-1/2 Obousměrná ráčna 1/2"

■ 60 zubů



BAHCO	□	∠	← mm →	g
7755-3/8	3/8"	5°	215	245
8155-1/2	1/2"	6°	260	575

NÁSTRČNÉ KLÍČE

Adaptér



BAHCO			mm
K6650-1/4-1P	1/4"	1/4"	50
K6650-3/8-1P	3/8"	1/4"	60
K6650-1/2-1P	1/2"	1/4"	60

Nástrčný klíč s magnetem



BAHCO		
KM6750-7	1/4"	7 mm
KM6750-8	1/4"	8 mm
KM6750-10	1/4"	10 mm
KM6750-13	1/4"	13 mm
KM6750-3/8	1/4"	3/8"

7400SR/S12 Sada nástrčných klíčů



3/8"

8 9 10 11 12 13 14 15 16 17 18 19

7408MD Sada nástrčných klíčů, dlouhých



3/8"



8 10 11 12 13 14 17 19 60-63

7400TORX-ER/S7 Sada nástrčných klíčů



3/8"



E8 E10 E11 E12 E14 E16 E18

7409MR/S7 Sada nástrčných klíčů s výstupem



3/8"



M3 M4 M5 M6 M7 M8 M10

7409TORX-TRR/S5 Sada nástrčných klíčů s výstupem



pro šrouby Torx® s pojistným kolíčkem

3/8"



TR27 TR30 TR40 TR45 TR50

7810MH Sada nástrčných klíčů



1/2"



10 11 13 14 15 16 17 19 21 22

7806MD Sada nástrčných klíčů, dlouhých



1/2"



10 13 14 17 19 22 82.6

7807TE Sada nástrčných klíčů



1/2"



E10 E12 E14 E16 E18 E20 E24

7808HM Sada nástrčných klíčů s výstupem



1/2"



M4 M5 M6 M7 M8 M10 M12 M14

7809TO Sada nástrčných klíčů s výstupem



1/2"



T20 T25 T27 T30 T40 T45 T50 T55 T60

Sada nástrčných klíčů na kolejniče:

6713MH Sada nástrčných klíčů



1/4"



4 4.5 5 5.5 6 7 8 9 10 11 12 13 14

6708DMB Sada nástrčných klíčů, dlouhých



1/4"



6 7 8 9 10 11 12 13 50.6

SADY NÁSTRČNÝCH KLÍČŮ



SL25
Sada nástrčných klíčů 

- 1/4"
- Metrické rozměry
- Vysoce výkonná legovaná ocel, matný povrch
- ISO 1174/DIN 3120



Bahco
Online-
Katalog >



○ 4 4.5 5 5.5 6 7 8 9 10 11 12 13
● 1/4" 60 zubů, úhel záběru 6°
● 1/4" 100 mm
○ 1/4" 1/4"
⊕ T10 15 20 25 30 40
● M 5 6 ⊕ PH 1 2



SL25AF
Sada nástrčných klíčů 

- 1/4"
- Palcové rozměry
- Vysoce výkonná legovaná ocel, matný povrch
- ISO 1174/DIN 3120



Bahco
Online-
Katalog >



○ 1/8" 5/32" 3/16" 7/32" 1/4" 9/32" 5/16" 11/32" 3/8" 7/16" 1/2" 9/16"
● 1/4" 60 zubů, úhel záběru 6°
● 1/4" 100 mm
○ 1/4" 1/4"
⊕ T10 15 20 25 30 40
● 7/32" 1/4" ⊕ PH 1 2



SL25L
Sada nástrčných klíčů 

- 1/4"
- Metrické rozměry
- S prodlouženými nástrčnými klíči
- Vysoce výkonná legovaná ocel, matný povrch
- ISO 1174/DIN 3120



Bahco
Online-
Katalog >



○ 4 4.5 5 5.5 6 7 8 9 10 11 12 13
○ 4 5 6 7 8 9 10 11 12 13
● 1/4" 60 zubů, úhel záběru 6°
● 1/4" 100 mm
○ 1/4" 1/4"
⊕ T10 15 20 25 30 40
● M 4 5 6
⊕ PH2 x 2 ⊕ PZ2 x 2



S330
Sada nástrčných klíčů 

- 1/4" + 3/8"
- Metrické rozměry
- Vysoce výkonná legovaná ocel, matný povrch
- ISO 1174/DIN 3120



Bahco
Online-
Katalog >



○ 10 11 12 13 14 15 16 17 18 19 20 22
○ 16 21
● 3/8" 60 zubů, úhel záběru 6°
● 3/8" 75 & 150 mm
● 3/8"
○ 3/8" 1/4"
● 1/4" 1/4"
● 1/4"
⊖ 4 5.5 7
⊕ PH 1 2 3 4
● M 3 4 5 6 7 8





S240
Sada nástrčných klíčů 24

- 1/2"
- Metrické rozměry
- Vysoce výkonná legovaná ocel, matný povrch
- ISO 1174/DIN 3120

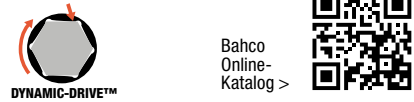

○	10 11 12 13 14 15 16 17 18 19 20 21 22 23
○	24 27 30 32
●	1/2" 60 zubů, úhel záběru 6°
●	1/2" 250 mm
●	1/2" 125 & 150 mm
●	1/2" &



S240AF
Sada nástrčných klíčů 24

- 1/2"
- Metrické + Palcové rozměry
- Vysoce výkonná legovaná ocel, matný povrch
- ISO 1174/DIN 3120

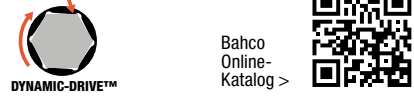

○	1/8" 3/8" 7/16" 1/2" 9/16" 5/8" 11/16" 3/4"
○	13/16" 7/8" 15/16" 1" 1.1/16" 1.1/8" 1.3/16" 1.1/4"
○	5/8" (16 mm) & 13/16" (21 mm)
●	1/2" 60 zubů, úhel záběru 6°
●	1/2" 250 mm
●	1/2" 125 & 150 mm
●	1/2" &



S330L
Sada nástrčných klíčů 53

- 1/4" + 3/8"
- Metrické rozměry
- ISO 1174/DIN 3120
- S prodlouženými nástrčnými klíči
- Vysoce výkonná legovaná ocel, matný povrch



○	10 11 12 13 14 15 16 17 18 19 20 22
○	10 11 12 13 14 15 17 18 19 20 22
○	16 21
●	3/8" 60 zubů, úhel záběru 6°
●	3/8" 75 & 150 mm
●	3/8" &
○	3/8" 1/4"
●	1/4" 1/4"
●	1/4" &
⊖	4 5.5 7
⊕	PH 1 2 3 ⊕ PZ 1 2
●	M 2.5 3 4 5 6 7 8
●	T10 T15 T20 T25 T30 T40



S560
Sada nástrčných klíčů 56

- 1/4" + 1/2"
- Metrické rozměry
- ISO 1174/DIN 3120
- S 12-hrannými nástrčnými klíči
- Vysoce výkonná legovaná ocel, matný povrch



○	4 4.5 5 5.5 6 7 8 9 10 11 12 13
○	1/4" 4 5 6 7 8 9 10 11 12 13
●	1/4" 72 zubů, úhel záběru 5°
●	1/4" &
●	1/4" 50 & 100 mm
●	1/4" &
○	10 11 12 13 14 15 17 19 22 24 27
○	1/2" 30 32
○	16 21
●	1/2" 72 zubů, úhel záběru 5°
●	1/2" 250 mm
●	1/2" 125 & 150 mm
●	1/2" &
○	1/2" 5/16"
○	1/4" 1/4"
●	1/4" 1/4"
●	5/16" T45 T50 T55
●	1.5 2 2.5

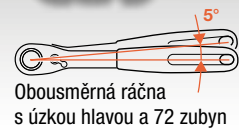

SADY NÁSTRČNÝCH KLÍČŮ



S18HEX
Sada hlavic Imbus

1/2" Šestihran

- Vysoce výkonná legovaná ocel, matný povrch
- ISO 1174/DIN 3120

18



S18TORX
Sada hlavic TORX

1/2" TORX®

- Vysoce výkonná legovaná ocel, matný povrch
- ISO 1174/DIN 3120

18

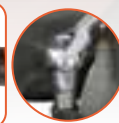

SW79
Sada hlavic s ráčnou s výkyvnou hlavou

1/4" + 1/2"

- Metrické rozměry
- Vysoce výkonná legovaná ocel, matný povrch
- ISO 1174/DIN 3120

79

NOVÉ



1/4"	4 4.5 5 5.5 6 7 8 10 11 12 13
1/4"	Ráčna s výkyvnou hlavou
1/4"	
1/4"	75 & 150 mm
1/2"	10 11 12 13 15 16 17 18 19 21 22 23 24 27
1/2"	Ráčna s výkyvnou hlavou
1/2"	125 & 250 mm
3/8"	1/2"
1/4"	1/4"
+	PH1 PH2
+	PZ1 PZ2
+	T10 T15 T20 T25 T27 T30
+	M 3 4 5 6
+	1/4" 1/4" 1/4" 1/4"
+	SL 3.0, 4.5, 5.5
+	1xPH1, 4xPH2, 1xPH3, 2xPH2G
+	1xPZ1, 4xPZ2, 1xPZ3
+	1xT10, 2xT15, 2xT20, 1xT25, 1xT27, 2xT30
+	M 3 4 5 6

NOVÉ

● M 4 5 6 7 8 10 12 14 17	←mm→ 60
● M 4 5 6 7 8 10 12 14 17	←mm→ 130



S9HEX
Sada hlavic Imbus

1/2" Šestihran

- Vysoce výkonná legovaná ocel, matný povrch
- ISO 1174/DIN 3120

9

NOVÉ

● T20 T25 T27 T30 T40 T45	←mm→ 60
● T50 T55 T60	
● T20 T25 T27 T30 T40 T45	←mm→ 130
● T50 T55 T60	



S9TORX
Sada hlavic TORX

1/2" TORX®

- Vysoce výkonná legovaná ocel, matný povrch
- ISO 1174/DIN 3120

9

● M 4 5 6 7 8 10 12 14 17

● T20 T25 T27 T30 T40 T45 T50 T55 T60

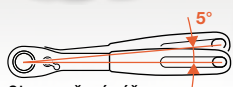

Obousměrná ráčna s úzkou hlavou a 72 zubůn

S95
Sada nástrčných klíčů

95

1/4" + 1/2"

- Metrické rozměry
- Vysoce výkonná legovaná ocel, matný povrch
- ISO 1174/DIN 3120

NOVÉ



Bahco Online-Katalog >



1/4"	4 4.5 5.5 6 7 8 9 10 11 12 13
1/4"	72 zubů, úhel záběru 5°
1/4"	
1/4"	75 & 150 mm
1/4"	&
1/2"	10 11 12 13 14 15 17 18 19 20 21 22 24 27 30 32
1/2"	16 21
1/2"	7 zubů, úhel záběru 5°
1/2"	125 & 150 mm
1/2"	&
1.5 2 2.5 3 4 5 6 8 10	
7, 8, 9, 10, 11, 12, 13, 14, 15, 16, 17, 18, 19	
1/4"	1/4"
1/4"	1/4"
4.5 5.5	
PH1 PH2 PH2 PH2 PH3 PH2G PH2G	
PZ1 PZ2 PZ2 PZ3	
T10 T15 T15 T15 T20 T20 T20 T25 T25 T27 T30	
M 3 4 5 6	



S106
Sada nástrčných klíčů

106

1/4" + 1/2"

- Metrické + Palcové rozměry
- Vysoce výkonná legovaná ocel, matný povrch
- ISO 1174/DIN 3120



Bahco Online-Katalog >



1/4"	4 4.5 5.5 6 7 8 9 10 11 12 13
1/4"	4 5 6 7 8 9 10 11 12 13
1/4"	60 zubů, úhel záběru 6°
1/4"	
1/4"	75 & 150 mm
1/4"	&
1/2"	10 11 12 13 14 15 17 19 20 22 24 27 30 32
1/2"	3/8" 7/16" 1/2" 9/16" 11/16" 3/4" 13/16" 7/8" 1/2" 1.3/16"
1/2"	16 21
1/2"	17 19 21 24
1/2"	60 zubů, úhel záběru 6°
1/2"	250 mm
1/2"	125 & 150 mm
1/2"	&
1/4"	1/4"
1/4"	1/4"
4 5.5 7	
PH 1 2 3 4	
M 3 4 5 6 7 8	
1.5 2 2.5	
8 9 10 11 12 13 14 15 17 19 21 24 27	
8-9 10-11 12-13 14-15	



SLX 17
Sada nástrčných klíčů

17

3/4"

- Metrické rozměry
- Vysoce výkonná legovaná ocel, matný povrch
- ISO 1174/DIN 3120

Bahco Online-Katalog >



3/4"	22 24 27 30 32 33 34 36 38 41 46 50
3/4"	
3/4"	500 - 815 mm
3/4"	200
3/4"	400
3/4"	



- Kufr z vysoce odolného polyetylénu HDPE; odolný vůči nárazům, olejům a teplotám

SADY RÁZOVÝCH NÁSTRČNÝCH KLÍČŮ



D/S10
Sada rázových nástrčných klíčů

10

1/2"

- Vysoce výkonná legovaná ocel, černé
- DIN 3129, ISO 2725



DYNAMIC-DRIVE™

○ 10 11 12 13 14 15 16 17 18 19	←mm→ 38
⊕ x2	



D/S14
Sada rázových nástrčných klíčů

14

1/2"

- Vysoce výkonná legovaná ocel, černé
- DIN 3129, ISO 2725



DYNAMIC-DRIVE™

○ 10 11 12 13 14 15 16 17 18 19	←mm→ 38
○ 20 21 22	
○ 24 27	←mm→ 45
⊕ x1	



DD/S10
Sada rázových nástrčných klíčů, dlouhých

10

1/2"

- Vysoce výkonná legovaná ocel, černé
- DIN 3129, ISO 2725



DYNAMIC-DRIVE™

○ 10 11 12 13 14 15 16 17 18 19	←mm→ 80
---------------------------------	---------



DD/S14
Sada rázových nástrčných klíčů, dlouhých

14

1/2"

- Vysoce výkonná legovaná ocel, černé
- DIN 3129, ISO 2725



DYNAMIC-DRIVE™

○ 10 11 12 13 14 15 16 17 18	←mm→ 80
○ 19 20 21	
○ 22 24 27	←mm→ 88
⊕ x3	



D-DD/S20
Sada rázových nástrčných klíčů

20

1/2"

- Vysoce výkonná legovaná ocel, černé
- DIN 3129, ISO 2725



DYNAMIC-DRIVE™

○ 10 11 12 13 14 15 16 17	←mm→ 38
○ 18 19	
○ 10 11 12 13 14 15 16 17	←mm→ 80
○ 18 19	
⊕ x3	

PRŮCHOZÍ RÁČNA A NÁ- STRČNÉ KLÍČE



K8901M/8 Sada rázových nástrčných klíčů



3/4"

- Vysoce výkonná legovaná ocel, černé
- DIN 3129, ISO 2725



21 22 24 27 30 32 36 41 | <mm> 51-58



- Průchozí obousměrná ráčna pro dlouhé závity, 3/8" (19 mm)
- 72 zubů, úhel záběru 5°
- S flexibilní hlavou pro lepší přístup



S140T Sada nástrčných klíčů s průchozí ráčnou



- Vysoce výkonná legovaná ocel, matný povrch
- DIN 3120, ISO 1174

10 11 12 13 14 15 16 17 19 21 22 24
3/8" 72 zubů
3/8" 3/8" <mm> 75



- Kufř z vysoce odolného polyetylénu HDPE; odolný vůči nárazům, olejům a teplotám



S530T Sada nástrčných klíčů s průchozí ráčnou



- Vysoce výkonná legovaná ocel, matný povrch
- DIN 3120, ISO 1174

10 11 12 13 14 15 16 17 19 21 22 24
8 9 10 11 12 13 14 15 16 17
E8 E10 E11 E12 E14 E16 E18 E20 E22
3/8" 72 zubů
3/8" 3/8" <mm> 75
3/8" 1/4" & 3/8" & 1/2"
3/8" 1/4" & 5/16"
5/16" M 7 8 10 12 mm
5/16" TTX 40H 45H 50H 55H
1/4" M 5 6 mm
1/4" TTX 20H 25H 27H 30H



K8906M/8 Sada rázových nástrč- ných klíčů, dlouhých



3/4"

- Vysoce výkonná legovaná ocel, černé
- DIN 3129, ISO 2725



21 22 24 27 30 32 36 41 | <mm> 95-100

KLÍČE

111- Sada očkoplochých klíčů

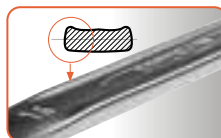

Rukojeť klíče U-profil,
menší plocha vidlice



Zesílený profil oka i vidlice

■ ISO 691 / ISO 7738 / ISO 3318 /
ISO 1711-1 / DIN 3113

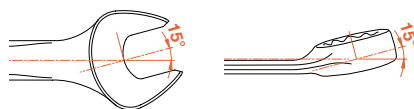

V plastovém zavínovacím pouzdrě, metrické



111M/11T

8 9 10 11 12 13 14 15
17 19 22 mm



111M/14T

6 8 9 10 13 14 15 17 19 22
24 27 30 32 mm



111M/26T

6 7 8 9 10 11 12 13 14 15 16 17 18 19
20 21 22 23 24 25 26 27 28 29 30 32 mm



Palcové rozměry



111Z/11T

3/8" 7/16" 1/2" 9/16"
5/8" 11/16" 3/4" 13/16"
7/8" 15/16" 1"



V plastovém držáku

- se sponou na opasek
- jednoduchá identifikace



111M/SH12

8 9 10 11 12 13 14
15 16 17 18 19 mm





Úzká hlava pro lepší přístupnost

Široké kontaktní plochy a snadno čitelné značení usnadňují práci

Vysoce výkonná legovaná ocel

Zesílený profil oka se zmenšeným vnějším průměrem usnadňuje obratnost ve stísněných prostorech

Pochromovaná a Micro matná vysokokvalitní povrchová úprava

Asymetrický U-profil rukojeti poskytuje lepší pohodlí při uchopení

12-bodový Dynamic-Drive profil zajišťuje delší životnost šroubů a matic

6M/10C

Sada oboustranných vidlicových klíčů



ISO 691 / ISO 1085 / ISO 10102 / ISO 3318

10



6x7 8x9 10x11 12x13 14x15 16x17 18x19 20x22 24x27 30x32 mm

S20/SH12

Sada očkoplochých klíčů, řada S



12



6 7 8 9 10 11 12 13 14 15 17 19 22 mm

1936M/7

Sada oboustranných trubkových klíčů

DIN 896-B
Z trubky, rovné

7+2



Obsah:
8x9 10x11 12x13 14x15 16x17 18x19 20x22 mm,
2 stupňovité tyčky 6-10 a 12-16 mm

4106-

Nastavitelný hákový klíč



Kloubová hlava s hákem pro různé průměry límců, kroužků a ložisek

BAHCO	mm	mm	g
4106-19-50	19-50	158	130
4106-20-35	20-35	165	185
4106-32-75	32-75	203	240
4106-35-60	35-60	210	170
4106-60-90	60-90	280	360
4106-90-155	90-155	335	610
4106-155-230	155-230	460	1200

KOMBINOVANÉ...

1RM- Kombinované ráčnové klíče



■ ISO 1711-1 / DIN 3113

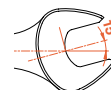
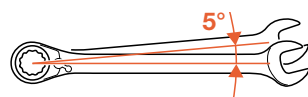

- Vysoce výkonná legovaná ocel
- Pochromovaná a micro matná vysokokvalitní povrchová úprava

BAHCO	mm	mm	g
1RM-6	6	128	27
1RM-7	7	140	35
1RM-8	8	140	38
1RM-9	9	150	48
1RM-10	10	159	59
1RM-11	11	165	67
1RM-12	12	172	82
1RM-13	13	178	95
1RM-14	14	191	113
1RM-15	15	200	130

BAHCO	mm	mm	g
1RM-16	16	208	158
1RM-17	17	226	180
1RM-18	18	237	213
1RM-19	19	248	233
1RM-21	21	290	343
1RM-22	22	290	343
1RM-24	24	323	503
1RM-27	27	359	550
1RM-30	30	393	750
1RM-32	32	425	900

Sada kombinovaných ráčnových klíčů, metrických



1RM/SH6 
8 10 12 13 14 17 mm

1RM/SH8 
8 10 11 12 13 14 17 19 mm



1RM/SH12 
8 9 10 11 12 13 14 15 16 17 18 19 mm

Palcové rozměry



1RZ/SH8 
5/16" 3/8" 7/16" 1/2" 9/16" 5/8" 11/16" 3/4"

10RM/SH6 Sada kombinovaných ráčnových klíčů, krátkých

■ ISO 3318 / DIN 3113

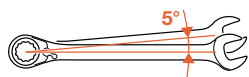

8 10 13 14 17 19 mm



41RM/SH8 Sada kombinovaných ráčnových klíčů, s výkyvnou hlavou

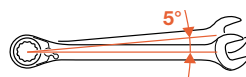
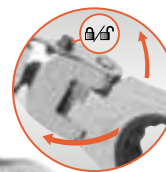

8 10 11 12 13 14 17 19 mm



... RÁČNOVÉ KLÍČE



42RM/S12

Sada ráčnových očkových klíčů s kloubem

12

- Nastavitelný kloub, který lze otočit o 360° a 180°



DYNAMIC-DRIVE™

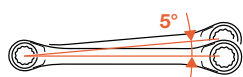

8 9 10 11 12 13 14 15 16 17 18 19 mm
+ 1 rukojeť



1320RM/SH8

Sada oboustranných ráčnových klíčů

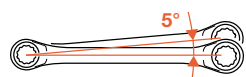

DYNAMIC-DRIVE™



8

6x7 8x9 10x11 12x13 14x15
16x17 18x19 22x24 mm

S4RM/3T

Sada oboustranných ráčnových klíčů, 4 v 1

3



DYNAMIC-DRIVE™

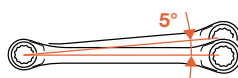

12 ROZMĚRŮ V 3 KLÍČÍCH

8x9x10x11mm
12x13x14x15 mm
16x17x18x19 mm



NASTAVITELNÉ KLÍČE

9029 C / 9031 C

Nastavitelné klíče ERGO™



- ISO 6787, DIN 3117, ASME B107.8M-2003 a BS 6333



Pohodlná a protiskluzová rukojeť z termoplastického materiálu

- Pochromované, přesně kalené s protikorozní úpravou

BAHCO	mm	mm	mm	g
9029 C	32	5	170	220
9031 C	38	6	218	340

9029-T / 9031-T

Nastavitelné klíče ERGO™ se štíhlými čelistmi



Pohodlná a protiskluzová rukojeť z termoplastického materiálu



- Fosfátováno, přesně kaleno s protikorozní úpravou

BAHCO	mm	mm	mm	g
9029-T	32	4.5	170	196
9031-T	38	4.5	218	325

80

Klasické nastavitelné klíče



- ISO 6787, DIN 3117, ASME B107.8M-2003 a BS 6333

- Pochromované, přesně kalené s protikorozní úpravou
Klíče 8074 a 8075 jsou černé

BAHCO	mm	mm	mm	g
8069 C IP	13	4	110	60
8070 C IP	20	4.9	155	132
8071 C IP	27	6	205	255
8072 C IP	30	8.6	255	400
8073 C IP	34	11.9	305	665
8074 C IP	44	14	380	1035
8075 C IP	53	17.7	455	1665
8074	44	14	380	1035
8075	53	17.7	455	1665

ADJUST 3

Sada nastavitelných klíčů



- Černé, přesně kaleno s protikorozní úpravou

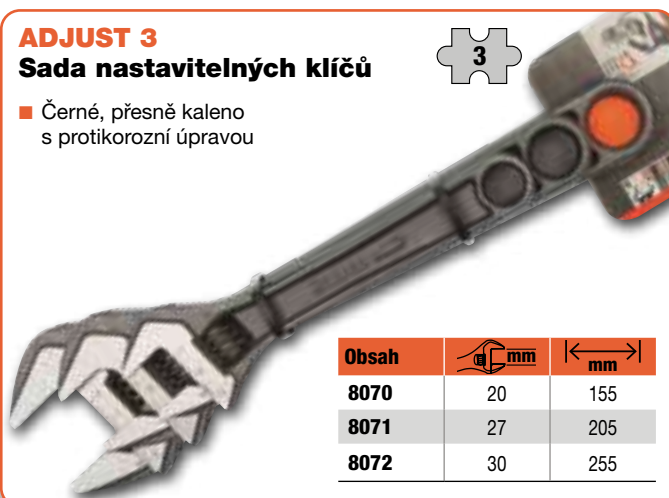

Obsah	mm	mm
8070	20	155
8071	27	205
8072	30	255

86

Nastavitelný klíč

- ISO 6787, DIN 3117, BS 6333, ASME B107.8M - 1996

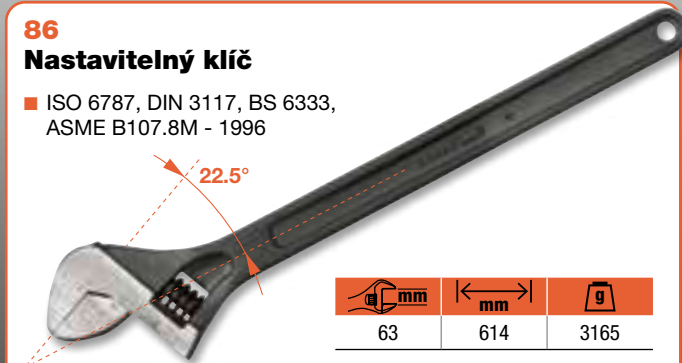

mm	mm	g
63	614	3165

- Fosfátováno, přesně kaleno s protikorozní úpravou

BESKRIFNING
OFFENTLIGGJORD AF

1892

Nastavitelný klíč byl vynalezen a patentován v roce 1892 J. P. Johanssonem, zakladatelem firmy Bahco. Od té doby společnost Bahco neustále pracuje na zlepšování designu a provedení.



ADJUST 9031/29

Sada nastavitelných klíčů ERGO™

■ Černěných



+40%

Obsah	 mm	 mm
9029 C	32	170
9031 C	38	218

BOČNÍ ŠTÍPACÍ KLEŠTĚ

2101G Boční štípací kleště ERGO™ pro elektrikáře

■ ISO 5749

ergo®



Ergonomická dvousložková rukojeť pro optimální uchopení



Progresivní řezné hrany:
Štípání tvrdých materiálů těsně u kloubu a měkkých materiálů u špičky



Indukčně kalené řezné hrany

Šroubení poskytuje vynikající chod a přesné nastavení řezných hran

BAHCO	mm	Fe+ mm	
2101G-125	125	2.2	černé
2101G-140	140	2.5	černé
2101G-160	160	2.7	černé
2101G-180	180	2.7	černé

BAHCO	mm	Fe+ mm	
2101GC-125IP	125	2.2	pochromované
2101GC-140IP	140	2.5	pochromované
2101GC-160IP	160	2.7	pochromované
2101GC-180IP	180	2.7	pochromované

21HDG-180 Boční štípací kleště ERGO™ pro mechaniky

■ ISO 5749

ergo®



Progresivní řezné hrany



Robustní zaoblená řezná hlava

Úzký tvar hlavy umožňuje dobrou přístupnost i s otevřenými čelistmi



mm	Fe+ mm
180	2.7

1520 G Pákové štípací kleště



63-64 Hrc

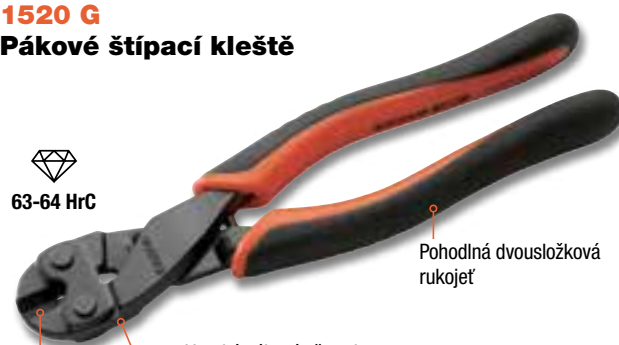

Vysoký pákový převod pro vysoký výkon při vyvinutí minimální námahy

Centrické přesné hrany na štípání strunového, tvrdého a měkkého drátu

mm	Fe+ mm
208	3.8



2101PG-160 Boční štípací kleště ERGO™

■ ISO 5749

speciálně na plasty

ergo®



Indukčně kalené řezné hrany

mm	CU	PA (Nylon)
160	1.5 mm	3.0 mm

KLEŠTĚ ERGO™

2628 G- Kombinované kleště ERGO™

■ ISO 5746

ergo®

Ergonomická dvou-
složková rukojeť pro
optimální uchopení



Indukčně kalené
řezné hrany

Úzký zaoblený tvar

2628 GC-
pochromované

2628 G
černé

BAHCO	mm	mm*	
2628 GC-160IP	160	2.0	pochromované
2628 GC-180IP	180	2.5	pochromované
2628 GC-200IP	200	3.0	pochromované
2628 G-160	160	2.0	černé
2628 G-180	180	2.5	černé
2628 G-200	200	3.0	černé

*Piano drát

2430 G- Kleště se špičatými plochy- mi čelistmi ERGO™

■ ISO 5745

ergo®

2430 GC-
pochromované

Štíhlé, půlkulaté a
vroubkované čelisti

2430 G
černé

Dlouhé špičky pro lepší přístup
ve stísněných prostorech

BAHCO	mm	CU mm	Fe mm	Fe+ mm
2430 GC-160 IP	160	3.0*	1.8*	1.6*
2430 GC-200 IP	180	3.0*	1.8*	1.6*
2430 G-160	160	3.0*	1.8*	1.6*
2430 G-200	180	3.0*	1.8*	1.6*

2427 G- Kleště se špičatými čelistmi ERGO™, se zahnutou špičkou

■ ISO 5745

ergo®

2427 GC-
pochromované

45°

Štíhlé, půlkulaté a
vroubkované čelisti

2427 G
černé

BAHCO	mm	CU mm	Fe mm	Fe+ mm
2427 GC-160IP	160	3.0	1.8	1.6
2427 GC-200IP	160	3.0	1.8	1.6
2427 G-200	200	3.0	1.8	1.6

72- Kleště s posuvným kloubem

■ ISO 8976

Pohodlná dvousložková rukojeť



Štíhlé čelisti pro lepší přístup
ve stísněných prostorech

25 nastavitel-
ných poloh

BAHCO	mm	mm
7223	49	200
7224	61	250
7225	71	300

82- Kleště s posuvným kloubem ERGO™

ergo®

■ ISO 8976

Tlačítko pro nastavení
rozevření jednou rukou



Pohodlná dvousložková
rukojeť

11 – 12
nastavitelných
poloh

BAHCO	mm	mm
8224CIP	45	250
8225CIP	55	315

1410/1420 Trubkové klíče ERGO™

ergo®

■ DIN 5234

■ Štíhlé čelisti pro lepší přístup
ve stísněných prostorech

Pohodlná dvousložková
rukojeť



Patentované progresivní ozubení
s indukčně kalenými čelistmi pro
lepší uchopení trubek

BAHCO	mm	mm	mm
1410	45	1" – 38 mm	320
1420	65	1½" – 57 mm	430

SPECIÁLNÍ KLEŠTĚ

9938

Sada kleští na pojistné kroužky

■ Pro vnitřní pojistné kroužky Ø 8 – 100 mm
a vnější pojistné kroužky Ø 3 – 100 mm

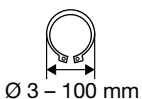
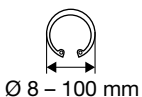

Pokrývá svým rozsahem cca 10 velikostí konvenčních kleští na pojistné kroužky



2928-160



2928-200



2928-250



■ Vyměnitelné špičky (rovné, zahnuté 15° a 90°)
pro vnitřní nebo vnější pojistné kroužky

Obsah	mm	mm	mm	
2928-160	160	7-26	3-35	5
2928-200	200	10-51	7-51	5
2928-250	250	46-102	32-102	6

9897

Sada kleští ERGO™

ergo®



Obsah

2101G-160 Boční štípací kleště

2628G-180 Kombinované kleště

2430G-160 Kleště se špičatými čelistmi

8224 Kleště s posuvným kloubem

28-29/S4

Sada kleští na pojistné kroužky

■ Pro vnitřní pojistné kroužky
a vnější pojistné kroužky



2800-180
s rovnou
špičkou Ø 19 – 60 mm



2890-180
se zahnutou
špičkou Ø 19 – 60 mm



2900-180
s rovnou
špičkou Ø 19 – 60 mm



2990-180
se zahnutou
špičkou Ø 19 – 60 mm

Pákové nůžky na plastové trubky



Ráčnový mechanismus

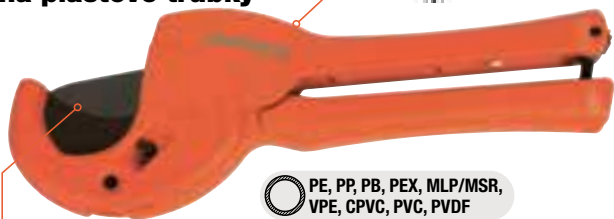

PE, PP, PB, PEX, MLP/MSR,
VPE, CPVC, PVC, PVDF

- Snazší, čistší a přesnější řez
- Jednoduchá výměna čepele
- Snadné vložení materiálu 1 rukou

Čepele z nerezové oceli s povlakem PTFE



BAHCO	mm max.	mm	g
411-35	35	220	273
411-42	42	240	435

2650 Konektorové kleště



1 | 2 | 3
Nastavitelné do 3 poloh

- S vyměnitelnými nylonovými vložkami a posuvným kloubem
- Zabraňují poškození povrchů

\leftarrow mm \rightarrow	\updownarrow mm
235	65

2855 Kleště na zkrucování drátů



30°
Zahnuté vroubkované čelisti, se stříhačem drátů

- Pro bezpečné a spolehlivé upevňování částí, vystavených vibracím, pomocí kroucení drátu
- Umožňují velmi rychlé a časově úsporné rovnoměrné zkrucování drátů

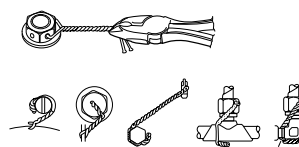

\leftarrow mm \rightarrow	\updownarrow mm	Fe+ mm
235		1.04

Nůžky na plech

- Kované čepele ze speciální kalené nástrojové oceli

Rukojeti ze sklolaminátu a nylonu



MA325

- Převodové vystřihovací nůžky
- Na rovný stříh a vystřihování z plechů



Měkké rukojeti s vratnou pružinou



MA351 / MA361

- Na stříhání ocelové slitiny s obsahem chromu a molybdenu
- Vyhnutá stříhací hlava pro lepší přístup

BAHCO	\leftarrow mm \rightarrow	Stříh	\updownarrow 1 mm	\updownarrow 2 mm
MA325	250	rovný	0.8	1.2
MA351	250	doleva	1.0	1.5
MA361	260	doprava	1.0	1.5

Max. stříhací kapacita 1 = nerezavějící ocel, 2 = ocel válcovaná za studena

316-2 Výstružník ve tvaru pera

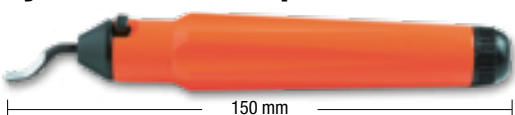

- Plastový kryt s extra HSS čepelí uvnitř
- Náhradní čepel je dostupná: 316-2-95

2951-250 Přidržovací kleště se štípací čelisti



Zakřivené tenké čelisti

Štípací čelisti na štípání olověné pájky apod.

\leftarrow mm \rightarrow	\updownarrow mm	Fe+ mm
250	63	3.0

PNEUMATICKÉ NÁŘADÍ

Rázové utahováký

120 mm



BPC813

1/2"

max. 678 Nm



BPC814

1/2"

max. 624 Nm



BPC815

1/2"

max. 1112 Nm



BPC817

3/4"

max. 2034 Nm

BAHCO	BAR	mm	l/min	Nm	Max Nm	min-1	dba	mm	kg	
BPC813	1/2"	6.3	10	113	407	678	10000	87	120	1.54
BPC814	1/2"	6.3	10	113	338	624	12000	87	142	1.24
BPC815	1/2"	6.3	10	113	786	1112	8000	88	187	1.91
BPC817	3/4"	6.2	10	198	1627	2034	5000	96	220	3.44

Video návody k použití & údržbě



BP500
Magnetický držák pro rázové utahováký

BP814A Rázový ráčnový utahovák



1/2"

max. 244 Nm

- Výkonnější a rychlejší než ráčna
- Lepší přístup než při použití rázového klíče
- Ideální pro práci v zúžených místech

BAR	mm	Nm	Max Nm	min-1	dba	mm	kg	
1/2"	6.2	10	195	244	7000	97	334	1.8

BP601 Excentrická bruska 5 mm

- Včetně brusného kotouče Velcro®



Dá se použít se systémy s centrálním odsáváním

mm	BAR	mm	l/min	W	min-1	dba	m/sec ²	mm	kg
152	6.3	10	255	224	11000	80	< 2.50	195	0.8

BP700
Mini ráčna

1/4"



BP820
Ráčna

3/8"



BP821
Ráčna

1/2"



BP218
Pneumatická ofukovací pistole

- Splňuje požadavky OSHA
- Vložka z mosazi



BAR	mm	l/min	dba	mm	kg
6.3	10	158	<80	210	0.15

BP219
Pneumatická ofukovací pistole

- Vložka z mosazi



BAR	mm	l/min	dba	mm	kg
6.3	10	68	<80	240	0.13

BP822
Přímá bruska 3 mm

Pogumovaná rukojeť



mm	BAR	mm	l/min	W	min ⁻¹	dba	m/sec ²	mm	kg
3	6.3	10	170	201	25000	85	4.52	165	0.5

Spirálové vzduchové hadice

- Pružné polyuretanová hadice s pevnými přípojkami s vnějším závitem na obou koncích



BAHCO	BAR		mm	m	kg
BPH1010B	6.3	1/4-1/4 BSP	10	10	0.86
BPH1310A	6.3	3/8-3/8 NPT	13	10	1.67

Bubny na vzduchové hadice



- Otočné 145° zavěšení
- Polypropylenový kryt odolný vůči korozi
- Západkový systém automaticky blokuje rozvinutou hadici na potřebné délce



Otevírací / zavírací pružina pro západkový systém

BAHCO	BAR		mm	m	kg
BPHRC815	15	1/4-1/4	8	15	5.5
BPHRC1015	15	3/8-3/8	10	14+1	5.9

PILOVÉ PÁSY

**Přesnost nezná
žádné kompromisy.**

**Naše standardy
kvality také ne.**

BI-METALOVÉ PILOVÉ PÁSY

Špičky zubů vyrobeny z vysoce účinné rychlořezné oceli v kombinaci s pružným nosným materiálem vedou k tomu, že pilové pásy jsou vysoce produktivní pro většinu aplikací. Víme kompletně uspokojit požadavky trhu pro víceúčelové, obrysové, trubkové, profilové řezání ve slévárnách či výrobních podnicích. Pilové pásy Sandflex® řezou různé druhy oceli, např. konstrukční oceli, temperované oceli, vysokolegované oceli, nerezavějící oceli, titan, slitiny na bázi niklu, litiny, mosazi, mědi a hliníku a jiné materiály.

KARBIDOVÉ PILOVÉ PÁSY

Premiové vysokovýkonné pilové pásy ze slinutého karbidu řezou rychleji a mají delší životnost než mnoho jiných pilových pásů. Jsou vhodné pro různé aplikace. Karbidové pilové pásy jsou speciálně navrženy pro vysoce efektivní řezání těžce obrobitelných a abrazivních materiálů, jakož i pro vysokovýkonné řezání velkých a těžko zpracovatelných obrobků.

Pro více informací o pilových pásích nás prosím kontaktujte.



Video -
Pilové pásy
Easy-Cut v praxi



Video - Výrobní proces
Karbidových
pilových pásů



Stáhněte si PDF
Katalog pilových pásů



PILNÍKY

1-478- Sada pilníků ERGO™

- V zavínovacím pouzdře



ergo®

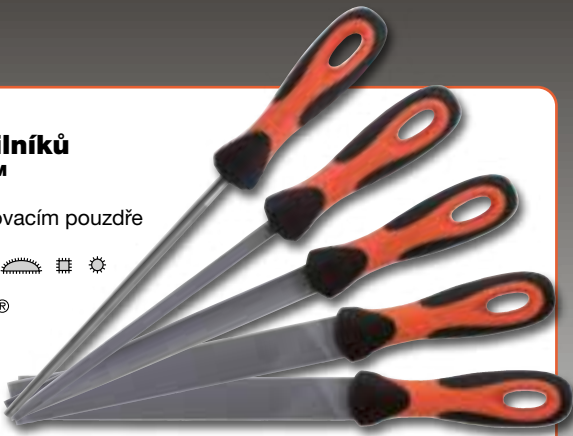

- Konec rukojeti zcela zakrývá stopku pilníku pro bezpečné a pohodlné držení
- Obsahuje po 1 ks: Plochý pilník (sek 2*), plochý, čtyřhranný, polkruhový a kruhový pilník (Sek 1*)

BAHCO	Obsahuje
1-478-08-1-2 160 mm	1-210-08-1-2; 1-230-08-1-2; 1-100-08-1-2; 1-100-08-2-2; 1-160-08-1-2
1-478-10-1-2 250 mm	1-210-10-1-2; 1-230-10-1-2; 1-100-10-1-2; 1-100-10-2-2; 1-160-10-1-2

* Sek 1 = Polohrubý, Sek 2 = Střední

Sady jehlových pilníků

- Na jemné pilování a lešticí práce



2-470-16-2-0



- Sek: 2 = Střední
- Obsahuje po 1 ks: plochý, plochý špičatý, půlkruhový, kruhový, trojhranný a čtyřhranný pilník a plastovou rukojeť

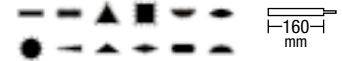

2-472-16-2-0



- Sek: 2 = Střední
- Obsahuje po 1 ks: plochý, plochý špičatý, trojhranný, čtyřhranný, půlkruhový, jazyčkový, kruhový, nožovitý, nízký tupouhlý trojhranný, mečovitý, značkovací pilník a pilník se zaoblenými hranami a plastovou rukojeť



1-100- Plochý pilník ERGO™

ergo®



BAHCO	160 mm	Sek*
1-100-08-1-2	150	1
1-100-08-2-2	150	2
1-100-10-1-2	200	1
1-100-10-2-2	200	2

1-210- Půlkruhový pilník ERGO™

ergo®



BAHCO	160 mm	Sek*
1-210-08-1-2	150	1
1-210-08-2-2	150	2
1-210-10-1-2	200	1
1-210-10-2-2	200	2

* Sek 1 = Polohrubý, Sek 2 = Střední

1-170- Trojhranný pilník ERGO™

ergo®



BAHCO	160 mm	Sek*
1-170-08-1-2	150	1
1-170-08-2-2	150	2
1-170-10-1-2	200	1
1-170-10-2-2	200	2

1-230- Kruhový pilník ERGO™

ergo®



BAHCO	160 mm	Sek*
1-230-08-1-2	150	1
1-230-08-2-2	200	1
1-230-10-1-2	150	2
1-230-10-2-2	200	2

DĚROVACÍ PILY

3834-SET-72-35/83

Sada děrovacích pil

- Bimetal s tvrzenými zuby z vysokolegované rychlořezné oceli
- Pro všechny opracovatelné materiály jako dřevo, ocel, kov, včetně nerezové oceli



	Ø mm	35 40 44 51 57 68 83
Upínací stopky	Ø 32-100 mm	
Sřídící vrták	Ø 6,35	



NOVÉ



4/6



max. 38 mm



4/6



max. 38 mm

NOVÉ

3834-SET-152

Sada děrovacích pil pro mechaniky, instalatéry a elektrikáře

- Bimetal s tvrzenými zuby z vysokolegované rychlořezné oceli
- Pro všechny opracovatelné materiály jako dřevo, ocel, kov, včetně nerezové oceli



	Ø mm	16 19 22 25 32 35 44 51 57 60 65 68 73 76 83
Upínací stopky	Ø 14-30 mm & Ø 32-210 mm	
Sřídící vrták	Ø 6,35	

3834-upsizer

Adaptér na upevnění vodící vykrúžovací pily

- Umožňuje upevnit menší vykrúžovací pilu jako vodící při vrtání velkého průměru

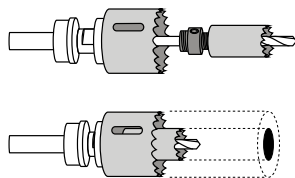

≥ 32 mm

< 32 mm



Praktické video



<https://youtu.be/F9wCwN0Wfvg>

PILY NA KOV

319 Ruční rámová pila na kov



- Lehký rám s ocelovým jádrem

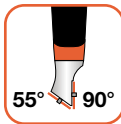

Upínací mechanismus v rukojeti

Sandflex® Bimetal
 <mm> 300 T^m 24



208 Mini rámová pilka na kov 250 mm

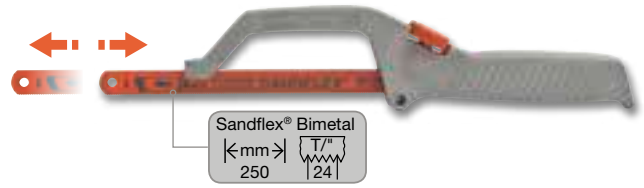

321 Vykrūžovací pila na kov

- Pilový list lze nastavit do 8 různých poloh

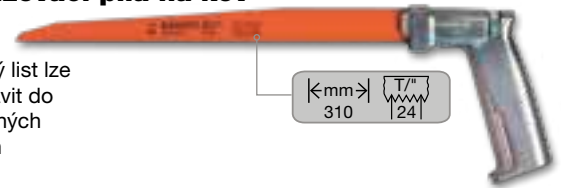

320 Ruční rámová pila na kov



- Výška rámu 110 mm
- Možnost upnutí listu pod 90° úhlem

Sandflex® Bimetal
 <mm> 300 T^m 24

268 Rámová pilka Junior

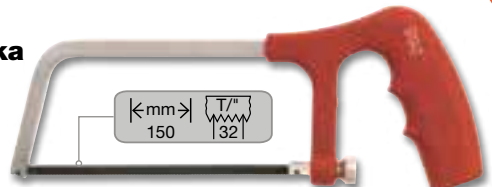

- Sklolaminátová zesílená rukojeť

Pilové listy do rámových pil Junior 268

- Na kovy a dřevo



BAHCO			<mm>
228-32-10P	10	32	150

3906 Pilové listy SANDFLEX® Bimetal



- Nezlomitelný, pružný bimetalový pilový list
- 20% rychlejší rezný výkon, 35% delší životnost

BAHCO			<mm>
3906-300-18-10P	10	18	300 x 13 x 0,65
3906-300-24-10P	10	24	300 x 13 x 0,65
3906-300-32-10P	10	32	300 x 13 x 0,65
3906-300-3P	3	18 / 24 / 32	300 x 13 x 0,65
3906-300-18-100	100	18	300 x 13 x 0,65
3906-300-24-100	100	24	300 x 13 x 0,65

* Cena za kus

KUFRY NA NÁŘADÍ

Pevné odolné kufrы

- Víko zajištěno 2 kovovými zámky
- Příhrádka na dokumenty



Centrální zamykací systém s jedním klíčem



Spodní plocha s odnímatelnými příčkami

Pogumovaná, měkká rukojeť



Řada 4750RC



Řada 4750RCW

Robustní teleskopická rukojeť z hliníku



Ø 60 x 20 mm



450 x 410 x 210 mm



4750RC02
Pevný odolný kufr

- Panel na nářadí ve víku s plastovými kapsami na obou stranách
- Spodní panel na nářadí s plastovými kapsami na jedné straně



465 x 410 x 255 mm



4750RCW01
Pevný odolný kufr s kolečky

- Panel na nářadí ve víku s plastovými kapsami na obou stranách
- Spodní panel na nářadí s plastovými kapsami na jedné straně
- S teleskopickou rukojetí a kolečky



465 x 405 x 255 mm



4750RCW011
Pevný odolný kufr s kolečky

- Panel na nářadí ve věku s upínacím gumovým popruhem na obou stranách
- Spodní panel na nářadí s upínacím gumovým popruhem na jedné straně
- S teleskopickou rukojetí a kolečky

4750PTB60 Přenosný plastový box na nářadí, prázdný

- Mimořádně odolný a vhodný pro použití v extrémních podmínkách

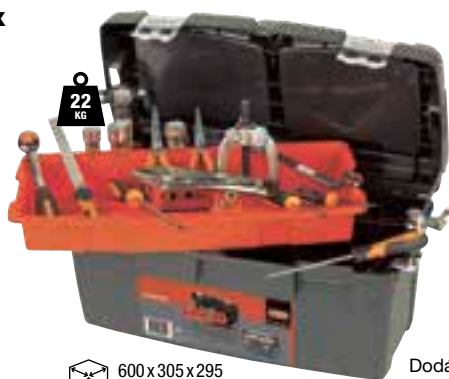

600 x 305 x 295 mm

Dodáváno bez nářadí

Dlouhá hliníková rukojeť

Dva zvenku vyjímatelné boxy



Stabilní pevné odolné kufry na nářadí z polypropylenu

- Odolné vůči korozi, nečistotám, vodě a hydraulickým kapalinám
- Kolíky z nerezové oceli
- Uzamykání pomocí visacích zámků



4750RCHD01 Pevný odolný kufr

- S polstrovaným ramenním popruhem



545 x 350 x 240 mm

4750RCHDW01 Pevný odolný kufr s kolečky

- S kolečky a teleskopickou rukojetí
- Kolečka: Ø 60 x 20 mm

630 x 480 x 290 mm

4750RCHDW02 Velký pevný odolný kufr s kolečky

- S kolečky a teleskopickou rukojetí
- Kolečka: Ø 60 x 37 mm

4750RCHDW01FF3

Pevný odolný kufr na kolečkách s teleskopickou rukojetí včetně 5 pěnových modulů s nářadím

1/4" + 3/8"

194

- Vhodné pro všechny typy letadel
- Metrické rozměry
- Obsahuje: FF2B12, FF2B13, FF2B14, FF2B15, FF2B16



Stáhněte si PDF
Produktový list

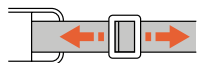

BRAŠNY NA NÁŘADÍ

4750FB1-19B
**19" uzavíratelná
brašna na nářadí
s krytem, prázdná**

Dodáváno bez nářadí

- S vyztuženým plastovým dnem
- Polstrovaný ramenní popruh a rukojeť

470 x 230 x 355 mm

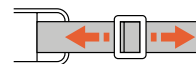
4750FB1-19A
**19" Otevřená brašna na nářadí
s plastovým dnem, prázdná**

 Dodáváno
bez nářadí

- Vodotěsné plastové dno

470 x 230 x 355 mm

4750-VDEC
**Kožený kufr pro
elektrikáře, prázdný**

- Hliníkový zesílený rám
- Vnitřní hliníková složka

290 x 190 x 445 mm

3100TB
**Otevřená brašna
na nářadí, prázdná**

- Vodotěsné dno
- Pohodlný polstrovaný ramenní popruh a rukojeť



400 x 600 x 400 mm

4750FB3-12
12" brašna na nářadí pro
elektrikáře, prázdná



Dodáváno bez nářadí

Skrytá plastová
 schránka ve
 spodní části

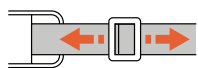

■ S vyztuženým plastovým
 dnem

285 x 285 x 190
 mm



4750FB4-18
18" brašna pro
laptop i nářadí,
prázdná

- Polstrovaná
 přihrádka pro
 laptop
- S vyztuženým
 plastovým
 dnem



Dodáváno
 bez nářadí

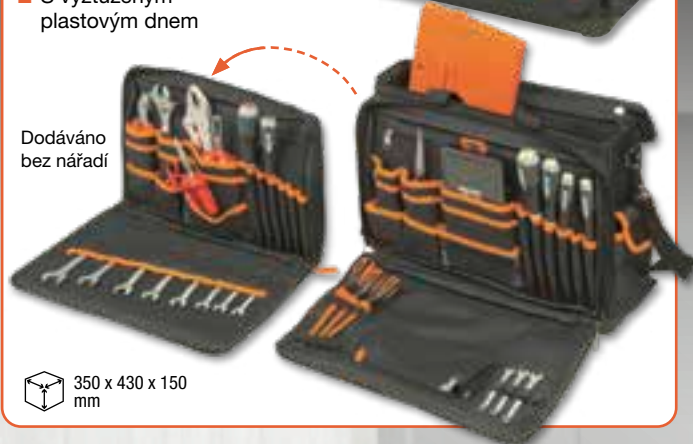

350 x 430 x 150
 mm

4750-VMPH-1
Pouzdro na
mobilní
telefon

- Na suchý zips, hodí se na
 jakýkoliv opasek



Organizér na nářadí, prázdný

Dodáváno
 bez nářadí



Dodáváno
 bez nářadí

Dodáváno
 bez nářadí

4750FB5A
Malý

275 x 170 x 55
 mm

4750FB5B
Střední

- Měkká pogumovaná rukojeť

330 x 270 x 70
 mm

4750FB5C
Velký

- Měkká pogumovaná rukojeť
- Síťovaná kapsa na dokumenty

400 x 300 x 90
 mm

AUTOMOTIVE

BBCE12-10

Plně automatický proces nabíjení řízený mikroprocesorem a udržovací nabíjení, **10 ampérů**, 8 fází

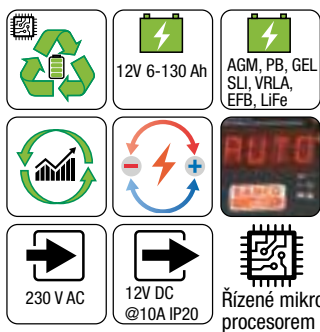

BH13000 Mobilní zvedák, 3 t

■ Dvojitý píst umožňuje dosáhnout maximální výšky na 6 pohybů



Video návody k použití & údržbě



CONNECT & FORGET

Automatický 8-fázový nabíjecí cyklus zefektivňuje nabíjecí cyklus a prodlužuje životnost vašeho akumulátoru.

1. KONTROLA AKUMULÁTORU	4. INTENZIVNÍ REŽÍM
2. OŽIVENÍ AKUMULÁTORU	5. ABSORBCE
3. POZVOLNÝ NÁBĚH	6. SLEDOVÁNÍ
	7. PLOVOUCÍ REŽÍM
	8. UDRŽOVACÍ FÁZE

BH4S- Hydraulické zvedáky, panenky

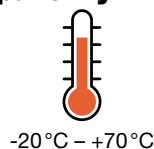

BAHCO	T	mm	mm	kg
BH4S2	2	181	345	2,2
BH4S4	4	194	372	3,4
BH4S6	6	216	413	5,0
BH4S8	8	230	457	5,7
BH4S12	12	230	465	7,8
BH4S20	20	242	452	13,0

BH5SP500QA Hydraulický zvedák převodovek

- Používá se pod zdviženými vozidly na bezpečné odstraňování, montáž nebo transport převodovek
- Rychlé dosažení úplné výšky po 38 zdvících díky dvourychlostní pumpě
- Vysoká stabilita díky široké bázi
- Odpružený snižovací mechanismus



Sedlo lze umístit shora dolů



BH5DP1000QA Hydraulický zvedák převodovek

- Používá se pod zdviženými vozidly na bezpečné odstraňování, montáž nebo transport převodovek
- Rychlé dosažení úplné výšky po 36 zdvících díky dvourychlostní pumpě
- Zvedání břemene pomocí nožního pedálu, čímž se uvolní ruce



SVÍTIDLA / INSPEKČNÍ NÁŘADÍ

5050 Stetoskop

- S ocelovou sondou



5515M Údržbářské zrcátko

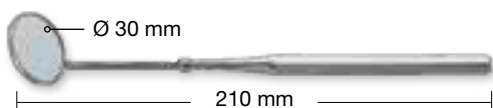

5515T-52 Teleskopické zrcátko s otočným kloubem

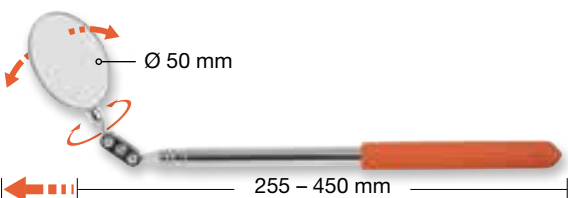

BLTS10 Tenká kapselní svítilna



BLTS7P Tužková kapselní svítilna



BFRL11 Čelovka

- 2 režimy osvětlení: potkávací (20%), dálkové (100%)
- Optická čočka

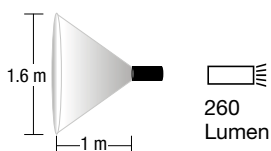

BLTFS6U Flexibilní svítilno s UV světlem

- UV světlo pro detekci netěsností; kontrolní světlo a baterka v jednom
- Indikátor nabíjení

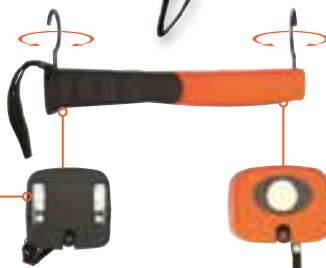
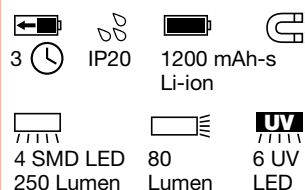

BLTFC1 Flexibilní svítilno s hliníkovým rámem

- Indikátor nabíjení

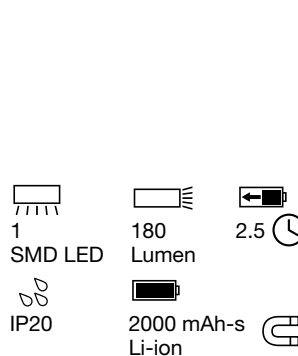

BLTS6I Indukční svítilno

- Silné a trvanlivé, odolné vůči nárazu
- Otočný háček
- Indikátor nabíjení

Indukční nabíjecí základna opatřena otvory pro zavěšení na stěnu

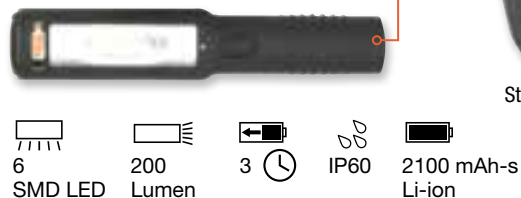

Stolní nabíječka

POZNÁMKY



BAHCO®



SNA Europe [Czech republic] s.r.o.
Holandská 2/4, 639 00 Brno
Tel.: +420 537 022 520
Fax: +420 537 022 200
E-mail: info.cz@snaeurope.com
www.bahco.com/cs-cz/

www.bahco.com